



Henman Trading Co. Ltd

General Supplier for Hotel & Construction Industry

We source & ship whatever you need from China

Email : | shen@hztomax.com | sales@henmantrading.com |

Mobile/Whatsapp/wechat:0086 15988447631 (for oversea call)



● 台式展示柜系列

台式制冷弧形蛋糕柜
台式制冷直角蛋糕柜
罗森款直角冷柜
罗森款弧形冷柜
寿司展示柜
红弧柜
台式制热弧形展示柜
台式制热直角展示柜

● 烘焙展示柜系列

西点柜
双层精品柜
双弧柜
立式蛋糕柜
便利店柜
三明治柜
矮立风柜

● 落地展示柜系列

元素款风冷展示柜
量子款风冷展示柜
落地直冷直角展示柜
落地直冷弧形展示柜

● 冰激凌展示柜系列

ELFI 台式冰激凌柜
SHERO 斜面单排冰激凌柜
BONJOUR 直角单排冰激凌柜
CONTROL 斜面双排冰激凌柜
PERFETTO 直角双排冰激凌柜
冰糖葫芦柜

● 熟食柜系列

鸭脖风冷展示柜
鸭脖直冷展示柜
串串风冷展示柜
前掀盖熟食柜

● 商超展示柜系列

盒马敞开制冷柜
盒马敞开制热柜
风幕柜

GELATO 
SHOWCASE



ELFI3

GELATO SHOWCASE



1. Hermetic compressor: High refrigerating capacity, low consumption and low noise levels.
2. Automatic Inversion cycle defrost, fast defrosting time, that doesn't affect product characteristics.
3. Glasses: Safety double glass with Heating element, can work very well in high humidity environment.
4. Straight Front glass for the best visibility.
5. The showcase can be made for Round barrel user.
6. Colors are available upon your request.

1. 全封闭进口制冷压缩机：全封闭压缩机，高效，低耗，低噪音。
2. 全自动逆循环化霜，不影响产品性能。
3. 玻璃：中空双钢化加热钢化玻璃，适合高湿度的场所。
4. 平板式前玻璃使产品有更好的展示效果。
5. 该款产品可做圆桶配置。
6. 颜色可根据要求定做。

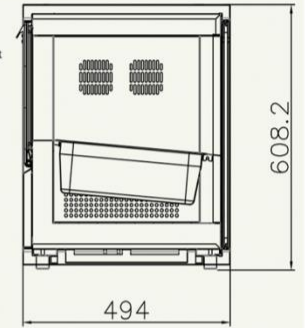

ELFI3冰淇淋柜CAD尺寸图

PANS MODEL / 份数盘			3
			3
<small>PANS 2, SL SIZE: 323*179*95; PANS 4, SIZE: 323*179*100; PANS 5L, SIZE: 360*180*120; GN 1/3</small>			

MODEL 型号	Dimensions: LxWxH (mm) 尺寸: 长*宽*高 (mm)	Weight/net/ (gross) 净重/毛重 (Kg)	Voltage V/ph/Hz 电源 V/ph/Hz	Input power (W) 输入功率 (W)
3	950*480*600	82/92	220-240/1/50	480

ELFI3



SHERO

GELATO SHOWCASE



- Ventilated 风冷
- Defrosting 自动化霜
- Refrigerant R404A 制冷剂 R404A
- Opening Glass 玻璃开闭方式
- Temperature 工作温度 -16~-18℃
- Climatic class °C/RH% 环境温度/湿度 30 / 75

1. Hermetic compressor: High refrigerating capacity, low consumption and low noise levels.
2. Automatic Inversion cycle defrost, fast defrosting time, that doesn't affect product characteristics.
3. Glasses: Safety double glass with Heating element, can work very well in high humidity environment.
4. Straight Front glass for the best visibility.
5. The showcase can be made for Round barrel user.
6. Colors are available upon your request.

1. 全封闭进口制冷压缩机组：全封闭压缩机，高效，低耗，低噪音。
2. 全自动逆循环化霜，不影响产品性能。
3. 玻璃：中空双面电加热钢化玻璃，适合高湿度的场所。
4. 平板式前玻璃使产品有更好的展示效果。
5. 该产品可做圆桶配置。
6. 颜色可根据要求定做。

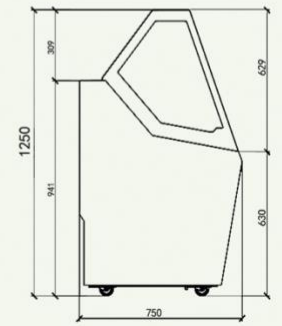

Shero冰淇淋柜CAD尺寸图

PANS MODEL / 份数盘	6	7	9
 PANS 2.5L SIZE:320*170*100mm GN 1/3			
 PANS 4L SIZE:320*170*100mm GN 1/3			
 PANS 5L SIZE:360*180*120mm			

MODEL 型号	Dimensions: LxWxH (mm) 尺寸:长*宽*高 (mm)	Weight(net)/ (gross) 净重/毛重 (Kg)	Voltage V/ph/Hz 电源 V/ph/Hz	Input power (W) 输入功率 (W)
6	1285*750*1250	140/158	220-240/1/50	
7	1463*750*1250	168/185	220-240/1/50	
9	1819*750*1250	210/238	220-240/1/50	

SHERO



CONTROL GELATO SHOWCASE



- Ventilated
风冷
- Defrosting
自动化霜
- Refrigerant R404A
制冷剂 R404A
- Temperatur
工作温度 -16~-18°C
- Climatic class C/PH
环境温度/湿度 30/7%

1. Hermetic compressor: High refrigerating capacity, low consumption and low noise levels.
2. Automatic inversion cycle defrost, fast defrosting time, that doesn't affect product characteristics.
3. Glasses: Safety double glass with Heating element, can work very well in high humidity environment.
4. Straight Front glass for the best visibility.
5. The showcase can be made for Round barrel user.
6. Colors are available upon your request.

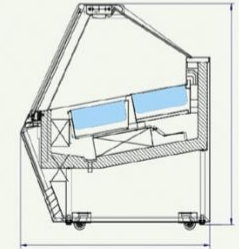

1. 全封闭进口制冷压缩机：全封闭压缩机
高效，低耗，低噪音。
2. 全自动逆循环化霜，不影响产品性能。
3. 玻璃：中空双面电加热钢化玻璃，适合高温度的场所。
4. 平板式前玻璃使产品有更好的展示效果。
5. 该款产品可做圆桶/份数盒配置。
6. 颜色可根据要求定做。

Control冰淇淋柜CAD尺寸图

PANS MODEL / 份数盒			12	16	18	20	24
			12	16	18	20	24
			8	10	12	12	14

CONTROL



MODEL 型号	Dimensions : LxWxH (mm) 尺寸：长*宽*高 (mm)	Weight/net / gross(Kg) 净重/毛重 (Kg)	Voltage V/ph/Hz 电源 V/ph/Hz	Input power(W) 输入功率(W)
1.2	1290*1174*1200	262/360	220-240/1/50	1400
1.6	1646*1174*1200	315/416	220-240/1/50	1600
1.8	1824*1174*1200	332/485	220-240/1/50	1750
2.0	2002*1174*1200	347/517	400/3/50	2700
2.4	2180*1174*1200	379/569	400/3/50	2750

Bonjour

GELATO SHOWCASE



Ventilated
风冷

Defrosting
自动化霜

Refrigerant R404A
制冷剂 R404A

Temperatur
工作温度 -16~-18°C



Climatic class °C/RH%
环境湿度/温度 30/75

1. Hermetic compressor: High refrigerating capacity, low consumption and low noise levels.
2. Automatic Inversion cycle defrost, fast defrosting time, that doesn't affect product characteristics.
3. Glasses: Safety double glass with Heating element, can work very well in high humidity environment.
4. Straight Front glass for the best visibility.
5. Colors are available upon your request.

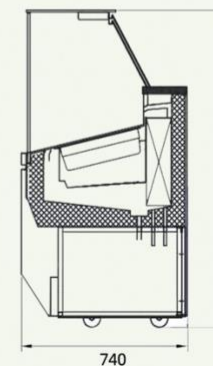
1. 全封闭进口制冷压缩机：全封闭压缩机，高效，低耗，低噪音。
2. 全自动逆循环化霜，不影响产品性能。
3. 玻璃：中空双面板电加热钢化玻璃，适合高湿度的场所。
4. 平板式前玻璃使产品有更好的展示效果。
5. 颜色可根据要求定做。



Bonjour 冰淇淋柜CAD尺寸图

PANS MODEL / 份数盘	6	7	9
  			
	6	7	9

Bonjour



MODEL 型号	Dimensions: LxWxH (mm) 尺寸:长*宽*高 (mm)	Weight/net/ 净重/毛重 (Kg)	(gross)	Voltage V/ph/Hz 电压 V/ph/Hz	Input power (W) 输入功率 (W)
6	1285*740*1250	149/167		220-240/1/50	850
7	1463*740*1250	188/205		220-240/1/50	850
9	1819*740*1250	235/263		220-240/1/50	1100

PERFETTOL

GELATO SHOWCASE



- Ventilated 风冷
- Defrosting 自动化霜
- Refrigerant R404A 制冷剂 R404A
- Temperatur 工作温度 -16~-18°C
- Climatic class°C/RH% 环境温度/湿度 50/75

1. Hermetic compressor: High refrigerating capacity, low consumption and low noise levels.
2. Automatic Inversion cycle defrost, fast defrosting time, that doesn't affect product characteristics.
3. Glasses: Safety double glass with Heating element, can work very well in high humidity environment.
4. Straight Front glass for the best visibility.
5. The showcase can be made for Round barrel user.
6. Colors are available upon your request.

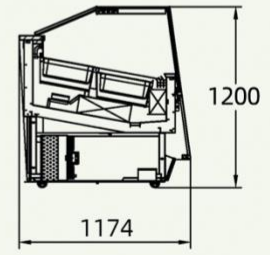

1. 全封闭进口制冷压缩机组：全封闭压缩机，高效，低耗，低噪音。
2. 全自动逆循环化霜，不影响产品性能。
3. 玻璃：中空双面电加热的钢化玻璃，适合高湿度的场所。
4. 平板式前玻璃使产品有更好的展示效果。
5. 该款产品可做圆桶配置。
6. 颜色可根据要求定做。

Perfettol冰淇淋柜CAD尺寸图

PANS MODEL / 份数盘		12	16	18	20	24
	PANS 2.5L SIZE:300*180*50mm GM 15	12	16	18	20	24
	PANS 4L SIZE:300*300*100mm GM 12	8	10	12	12	14

PERFETTOL

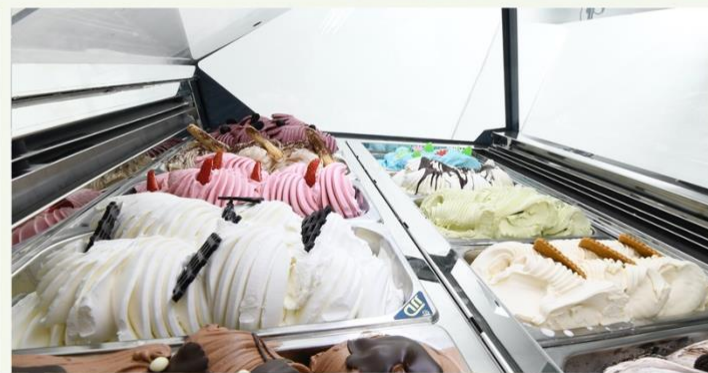

MODEL 型号	Dimensions : LxWxH (mm) 尺寸：长*宽*高 (mm)	Weight(net / gross)(Kg) 净重/毛重 (Kg)	Voltage V/ph/Hz 电压 V/ph/Hz	Input power(W) 输入功率(W)
1.2	1290*1174*1200	272/370	220-240/1/50	1400
1.6	1646*1174*1200	325/426	220-240/1/50	1600
1.8	1824*1174*1200	342/495	220-240/1/50	1750
2.0	2002*1174*1200	367/527	400/3/50	2700
2.4	2180*1174*1200	389/579	400/3/50	2750

弧形冰糖葫芦柜

风道除雾
Duct demisting

工作温度-5~-10°C
Working temperature

铜管制冷
Copper tube refrigeration

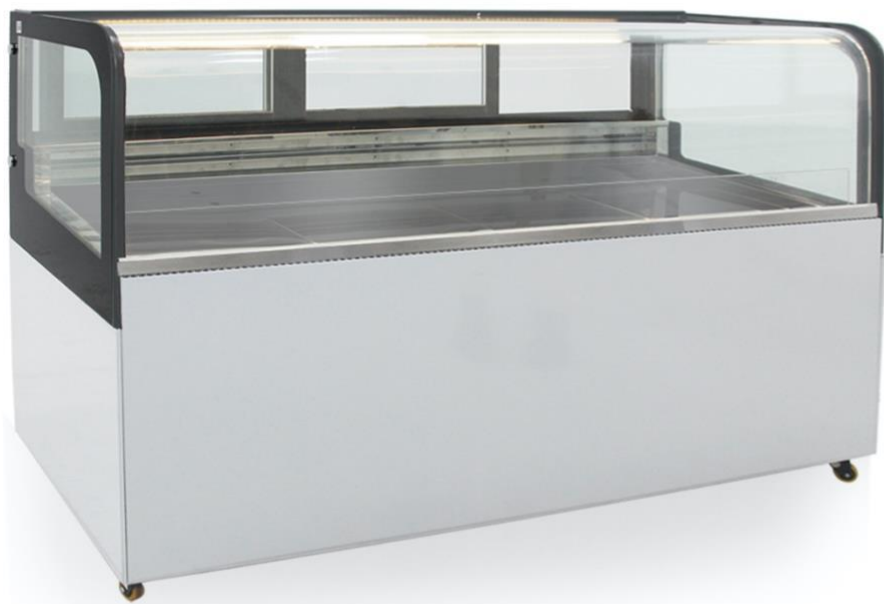

西麦得冰糖葫芦柜优势:

- ①、90°热弯玻璃自带风道除雾保证展示效果，柜内-5°C--10°C冷风冷冻系统。
- ②、进口丹福斯制冷机组，全铜管蒸发器，全铜管冷凝器。
- ③、意大利进口DIXELL温控器使柜内温差不超过2
- ④、下围材质采用静电喷涂板材质，可更换大理石或不锈钢材质。
- ⑤、后移门设计，防止开门取物时，冷风流失。



产品实拍细节图

弧形冰糖葫芦柜

款式	尺寸(长X宽X高)	功率	工作温度
0.9M	900x700x1200mm	600w/220v	-5~-10°C
1.2M	1200x700x1200mm	830w/220v	-5~-10°C
1.5M	1500x700x1200mm	1000w/220v	-5~-10°C
1.8M	1800x700x1200mm	1200w/220v	-5~-10°C

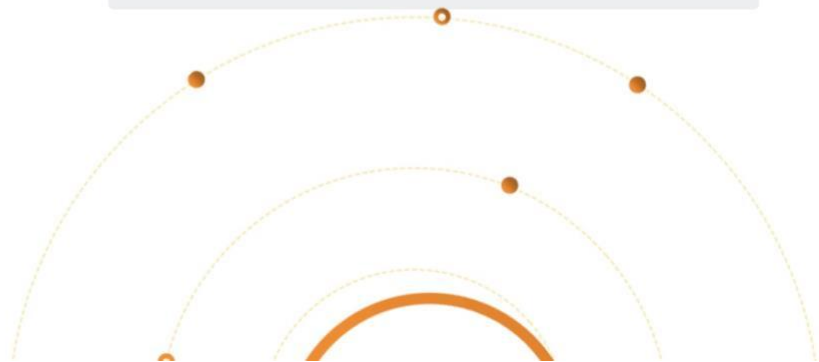

直角冰糖葫芦柜

风道除雾
Duct demisting

工作温度-5~-10°C
Working temperature

铜管制冷
Copper tube refrigeration



西麦得冰糖葫芦柜优势:

- ①、90° 直角玻璃自带风道除雾保证展示效果，柜内 -5°C— -10°C冷风冷冻系统。
- ②、进口丹福斯制冷机组，全铜管蒸发器，全铜管冷凝器。
- ③、意大利进口DIXELL温控器使柜内温差不超过2
- ④、下围材质采用静电喷涂板材质，可更换大理石或不锈钢材质。
- ⑤、后移门设计，防止开门取物时，冷风流失。



产品实拍细节图

直角冰糖葫芦柜

款式	尺寸(长X宽X高)	功率	工作温度
0.9M	900x700x1200mm	600w/220v	-5~-10°C
1.2M	1200x700x1200mm	830w/220v	-5~-10°C
1.5M	1500x700x1200mm	1000w/220v	-5~-10°C
1.8M	1800x700x1200mm	1200w/220v	-5~-10°C

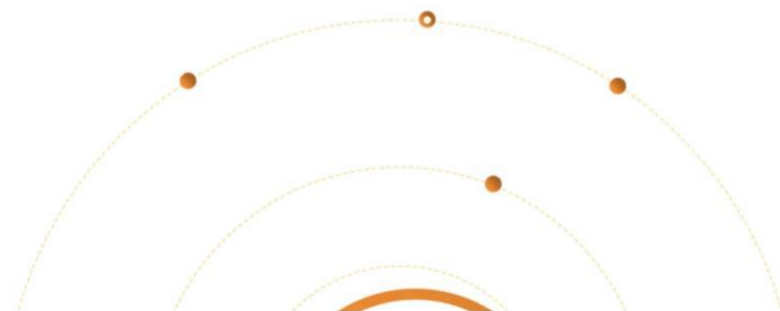

蛋糕展示柜

烘焙店蛋糕 慕斯 甜品 西点解决方案



量子款蛋糕柜 QUANTUM CAKE FREEZER



- Ventilated
风冷循环
- Defrosting
自动化霜
- Refrigerant 134A
制冷剂 134A
- Temperature
工作温度 0-8°C
- Climate class / RH%
环境温度/湿度 30/70°C

1. Double layer hollow toughened glass, and the way of demisting by electrodeposited film.
2. Cyclopentane foaming, refrigerant R404A, has fast cooling speed and slow dispersive cooling.
3. Internal screw evaporator is used to increase heat exchange area and save energy and electricity.
4. The top layer is made of marble, and the bottom layer is made of spray plate, 304 stainless steel and large size Marble material can be selected; double layer aluminum alloy sliding door, 3-layer frame, layer frame The material and tilt of the mirror can be adjusted. It is suitable for storing drinks, fruits, high-grade Western food, etc.

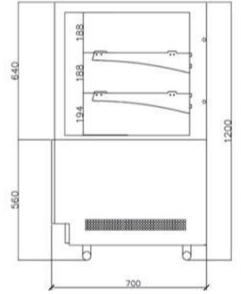

量子款蛋糕柜CAD尺寸图

1. 双层中空钢化玻璃，电镀膜除雾方式。
2. 环戊烷整体发泡，制冷剂R404A，制冷速度快，散冷慢。
3. 使用内螺纹蒸发器，增加换热面积，同时更节能省电。
4. 顶层为大理石材质，底部材质有喷涂板、304不锈钢和大理石材质可选择；双层铝合金推拉门，3层层架，层架为镜面不锈钢材质，高低和倾斜度可以调节。适用于存放饮品、水果、高档西点等。

Holland
好利来

丹香
DanLex

达利园

合作伙伴

85°C
Daily
Cafe

BreadTalk
面包新语

AILI®
爱的礼物



MODEL 型号	Dimensions: LxWxH (mm) 尺寸: 长*宽*高 (mm)	Weight(net)/ 净重/毛重 (Kg)	(g ss)	Voltage V/ph/Hz 电源 V/ph/Hz	Input power (W) 输入功率 (W)
12	1200*900*1200	135/152		220-240/1/50	980
15	1500*900*1200	160/180		220-240/1/50	1050
18	1800*900*1200	200/225		220-240/1/50	1210

元素款直角蛋糕柜



- 1.层架不锈钢加铝合金型材（层架间距可自由调节）。
 - 2.风机铝扇叶，耐高温，不影响转速，不易变形。
 - 3.冷凝风机铜线铜芯，对比铝芯耐高温，稳定性高，成本高。
 - 4.蒸发风机转动方式滚珠轴承，行业内最高标准（同行业价格低的厂家多为含油风机，低温下影响风扇转速）。
 - 5.尚方温控器（智能温控，节能省电，保鲜效果更好）。
 - 6.蒸发器，冷凝器全为内螺纹全铜管，增大换热面积。
- 适用于存放水果饮料、奶油蛋糕等。
1. Stainless steel and aluminum alloy profiles (the shelf spacing can be adjusted freely).
 2. Aluminum fan blade of fan is resistant to high temperature, does not affect rotation speed and is not easy to deform.
 3. Compared with aluminum core, copper core of condenser fan has high temperature resistance, high stability and high cost.
 4. The ball bearing of evaporation fan is the highest standard in the industry, Low temperature affects the fan speed).
 5. Shangfang temperature controller (intelligent temperature control, energy saving and power saving, better preservation effect).
 6. The evaporator and condenser are all copper tubes with internal thread to increase the heat exchange area.
- Suitable for storing fruit drinks, cream cakes, etc.

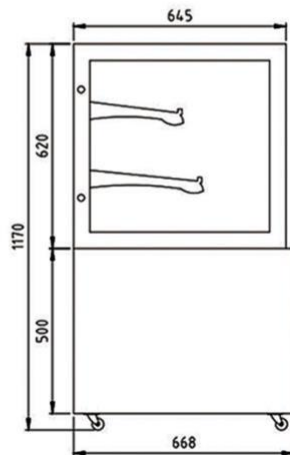

尺寸、颜色、制冷制热均可定做

型号 (Model)	规格 (MM)			功率(KW)	温度(°C)
	长 (L)	宽 (W)	高 (H)		
XMD-JZ09	900	670	1230	0.40KW	2-8°C
XMD-JZ12	1200	670	1230	0.45KW	2-8°C
XMD-JZ15	1500	670	1230	0.49KW	2-8°C
XMD-JZ18	1800	670	1230	0.55KW	2-8°C
XMD-JZ21	2100	670	1230	0.59KW	2-8°C

元素款弧形蛋糕柜



1. 层架不锈钢加铝合金型材（层架间距可自由调节）。
 2. 风机铝扇叶，耐高温，不影响转速，不易变形。
 3. 冷凝风机铜线圈芯，对比铝芯耐高温，稳定性高，成本高。
 4. 蒸发风机转动方式滚珠轴承，行业内最高标准（同行业价格低的厂家多为含油风机，低温下影响风扇转速）。
 5. 尚方温控器（智能温控，节能省电，保鲜效果更好）。
 6. 蒸发器，冷凝器全为内螺纹全铜管，增大换热面积。
- 适用于存放水果饮料、奶油蛋糕等。

1. Stainless steel and aluminum alloy profiles (the shelf spacing can be adjusted freely).
 2. Aluminum fan blade of fan is resistant to high temperature, does not affect rotation speed and is not easy to deform.
 3. Compared with aluminum core, copper core of condenser fan has high temperature resistance, high stability and high cost.
 4. The ball bearing of evaporation fan is the highest standard in the industry, Low temperature affects the fan speed).
 5. Shangfang temperature controller (intelligent temperature control, energy saving and power saving, better preservation effect).
 6. The evaporator and condenser are all copper tubes with internal thread to increase the heat exchange area.
- Suitable for storing fruit drinks, cream cakes, etc.

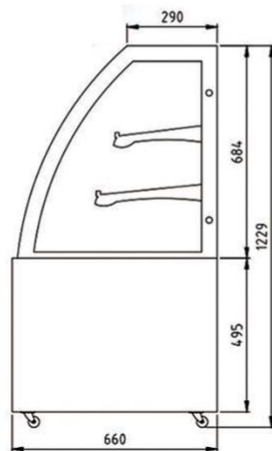

尺寸、颜色、制冷制热均可定做

型号 (Model)	规格 (MM)			功率(KW)	温度(°C)
	长 (L)	宽 (W)	高 (H)		
XMD-JH09	900	670	1230	0.40KW	2-8°C
XMD-JH12	1200	670	1230	0.45KW	2-8°C
XMD-JH15	1500	670	1230	0.49KW	2-8°C
XMD-JH18	1800	670	1230	0.55KW	2-8°C
XMD-JH21	2100	670	1230	0.59KW	2-8°C

西点柜 WEST POINT FREEZER



- Ventilated
风冷循环
- Defrosting
自动化霜
- Refrigerant 134A
制冷剂 134A
- Temperature
工作温度 0-8°C
- Climate class C / RH%
工作温度 0-8°C

1. High power imported unit, Danfoss compressor, Shangfang temperature controller, copper condenser and evaporator, Double layer ultra white tempered glass hollow, the lower wall material can be customized stainless steel or marble.
2. Three sides of the glass are coated with argon at three sides, More beautiful, ensure the display effect.
3. Cyclopentane foaming, refrigerant R404A, fast cooling speed, slow cooling, compressor working, Short time, ensure that the humidity is controlled at about 80%, to solve the phenomenon of food being blown dry.
4. Internal screw evaporator is used to increase heat exchange area, and hexagonal screws are used for better fixation. Suitable for storing French desserts, high-end cream cakes, etc.

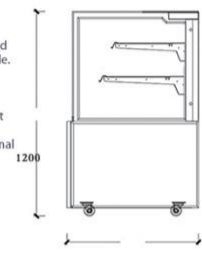

西点柜CAD尺寸图

1. 大功率进口机组，丹弗斯压缩机，尚方温控器，全铜冷凝器和蒸发器，双层超白钢化玻璃中空，下围材质可定制不锈钢或大理石。
2. 三面风道除雾+三面电镀膜除雾玻璃，侧玻璃冲氩气，45度夹角的玻璃更美观，保证展示效果。
3. 环戊烷整体发泡，制冷剂R404A，制冷速度快，散冷慢，压缩机工作时间短，保证湿度控制在80%左右，解决了食物被吹干现象。
4. 使用内螺纹蒸发器，增加换热面积；全部使用六角螺丝，固定性更好。适用于存放法式甜点、高端奶油蛋糕等。

合作伙伴



MODEL 型号	Dimensions: LxWxH (mm) 尺寸: 长*宽*高 (mm)	Weight/net/ (gross) 净重/毛重 (Kg)	Voltage V/ph/Hz 电源 V/ph/Hz	Input power (W) 输入功率 (W)
12	1200*800*1200	160/180	220-240/1/50	
15	1500*800*1200	170/190	220-240/1/50	
18	1800*800*1200	180/200	220-240/1/50	

矮立风柜 RED ARC FREEZER



- 1. High power imported unit, Danfoss compressor, Shangfang temperature controller.
 - 2. Internal screw evaporator is used to increase heat exchange area and save energy and electricity; Cover pole evaporation fan, all use hexagon screw, better fixation.
 - 3. The front and lower wall magnetic heat dissipation baffle is convenient to remove and clean the radiator, and the front and rear heat dissipation effect is better.
 - 4. Unique air cooling circulation system, the back wind makes the temperature of each layer uniform, and the back wind is due to the wind curtain. The barrier system only circulates in the cabinet and does not run air. Each shelf has a long air outlet.
- It is suitable for storing fruits, yoghurt, drinks, Western food and other refrigerated food.

- 1. 大功率进口机组，丹弗斯压缩机，尚方温控器。
 - 2. 使用内螺纹蒸发器，增加换热面积，同时更节能省电；罩极蒸发风机，全部使用六角螺丝，固定性更好。
 - 3. 前下围吸磁散热挡板，方便拆卸清理散热器，前后散热效果更佳。
 - 4. 独特的风冷循环系统，后背出风让每层温度均匀化，后背风因为风幕阻隔系统只在柜内循环不跑风，每个层架都有长条出风口。
- 适用于存放水果、酸奶、饮料、西点等冷藏食品。

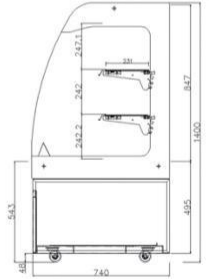

矮立风柜CAD尺寸图

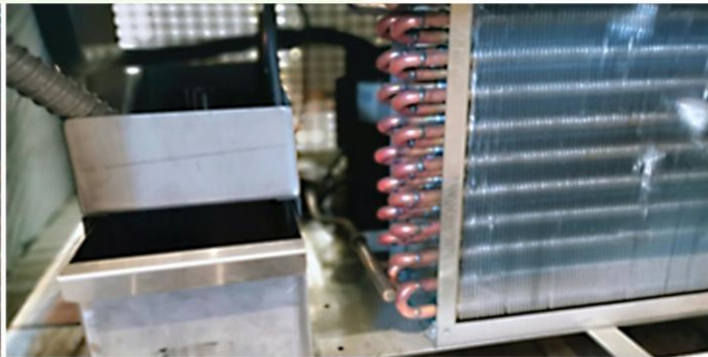
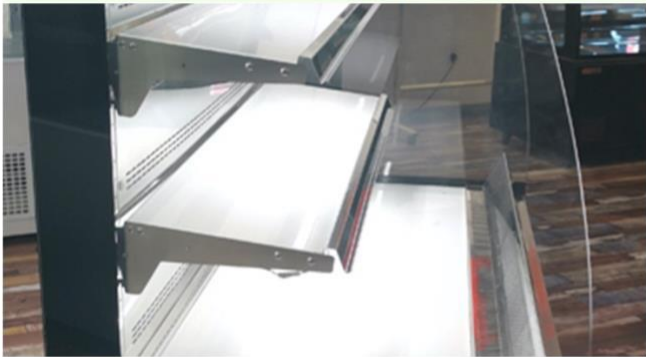

合作伙伴

MODEL 型号	Dimensions : LxWxH (mm) 尺寸: 长*宽*高 (mm)	Weight(net)/ 净重/毛重 (Kg)	(gross)	Voltage V/ph/Hz 电源 V/ph/Hz	Input power (W) 输入功率 (W)
12	1200*740*1400	160/180		220-240/1/50	360
15	1500*740*1400	170/190		220-240/1/50	400
18	1800*740*1400	180/200		220-240/1/50	450

精品柜

BOUTIQUE FREEZER



- Ventilated 风冷循环
- Defrosting 自动化霜
- Refrigerant 134A 制冷剂134A
- Temperature 工作温度0-8°C
- Climate class / R/NH 工作温度0-8°C

1. High power imported unit, Danfoss compressor, Shangfang thermostat, copper condenser and Evaporator, lower wall material can be customized stainless steel or marble.
 2. The whole cabinet adopts double-layer ultra white tempered glass, and the top glass and front glass adopt electric coating for mist removal. No leakage of air conditioning, 45 degree angle glass is more beautiful, to ensure the display effect.
 3. Cyclopentane foaming, more lasting heat preservation effect, fast cooling speed, slow cooling, guarantee The humidity was controlled at about 80%, which solved the problem of food drying.
 4. Internal screw evaporator is used to increase heat exchange area and save energy and electricity.
- Suitable for storage in chocolate, mousse and other high-end pastry.

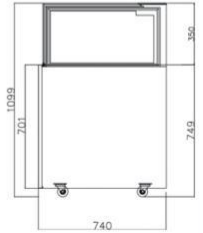

精品柜CAD尺寸图

- 1.大功率进口机组，丹弗斯压缩机，尚方温控器，全铜冷凝器和蒸发器，下围材质可定制不锈钢或大理石。
- 2.整柜采用双层超白钢化玻璃，顶玻璃和前玻璃采用电镀膜除雾；冷气不外漏，45度夹角的玻璃更美观，保证展示效果。
- 3.环戊烷整体发泡，保温效果更持久，制冷速度快，散冷慢，保证湿度控制在80%左右，解决了食物被吹干现象。
- 4.使用内螺纹蒸发器，增加换热面积，同时更节能省电。适合存放于巧克力、慕斯等高档西点。

Holland
好利来

丹香
DanLex

达利园

合作伙伴

85°C
Daily
Cafe

BreadTalk
面包新语

AILI®
爱的礼物

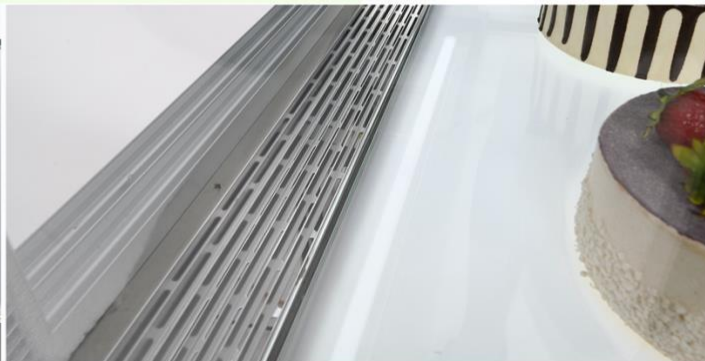

MODEL 型号	Dimensions: LxWxH (mm) 尺寸:长*宽*高 (mm)	Weight/net/ (gross) 净重/毛重 (Kg)	Voltage V/ph/Hz 电源 V/ph/Hz	Input power (W) 输入功率 (W)
12	1200*740*1100	135/152	220-240/1/50	710
15	1500*740*1900	160/180	220-240/1/50	970
18	1800*740*1900	200/225	220-240/1/50	1110

三明治柜

SANDWICH CABINET



1. High power imported unit, Danfoss compressor, Shangfang temperature controller.
 2. The internal screw evaporator is used to increase the heat exchange area, and hexagonal screws are used for better fixation.
 3. Forced air pressure design, double air outlet, any wind speed point is the same, humidity can keep 80%.
 4. The table is covered with LED light-emitting board, and the top is also equipped with LED light. The base material is marble, and other materials can be customized.
 5. The top stainless steel bracket covers the light bar, which can be added or not, and cannot be removed.
- Suitable for storing sandwiches, sushi, etc.

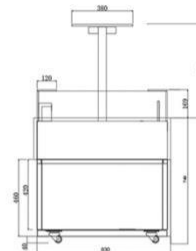

三明治柜CAD尺寸图

1. 大功率进口机组,丹弗斯压缩机,尚方温控器。
 2. 使用内螺纹蒸发器,增加换热面积全部使用六角螺丝,固定性更好。
 3. 强制压风设计,双风道出风口,任何一个风速点相同,湿度能保持80%。
 4. 台面覆盖LED发光板,顶部也有LED灯,底座材质定做其它材质。
 5. 顶部不锈钢支架,覆盖灯条,可加可不加,不能拆卸。
- 适用于存放三明治、寿司等。

Holland
好利来

丹香
DanLex

达利园

合作伙伴

85°C
Daily Cafe

BreadTalk
面包新语

AILI®
爱的礼物



MODEL 型号	Dimensions: LxWxH (mm) 尺寸:长*宽*高 (mm)	Weight (net/ (gross) 净重/毛重 (Kg)	Voltage V/ph/Hz 电源 V/ph/Hz	Input power (W) 输入功率 (W)
12	1200*850*900/1300	135/152	220-240/1/50	1030
15	1500*850*900/1300	160/180	220-240/1/50	1100
18	1800*850*900/1300	200/225	220-240/1/50	1260

立式蛋糕柜

VERTICAL CAKE CABINET



- Ventilated
风冷循环
- Defrosting
自动化霜
- Refrigerant 134A
制冷剂134A
- Temperature
工作温度0-8℃
- Climate class / RH
工作温度0-8℃

1. Double layer hollow toughened glass, and the way of demisting by electrodeposited film.
 2. Cyclopentane foaming, refrigerant R404A, has fast cooling speed and slow dispersive cooling.
 3. Internal screw evaporator is used to increase heat exchange area and save energy and electricity.
 4. The top layer is made of marble, and the bottom layer is made of spray plate, 304 stainless steel and large size Marble material can be selected; double layer aluminum alloy sliding door, 3-layer frame, layer frame The material and tilt of the mirror can be adjusted.
- It is suitable for storing drinks, fruits, high-grade Western food, etc.

1. 双层中空钢化玻璃，电镀膜除雾方式。
 2. 环戊烷整体发泡，制冷剂R404A，制冷速度快，散冷慢。
 3. 使用内螺纹蒸发器，增加换热面积，同时更节省电。
 4. 顶层为大理石材质，底部材质有喷涂板、304不锈钢和大理石材质可选择；双层铝合金推拉门，3层层架，层架为镜面不锈钢材质，高低和倾斜度可以调节。
- 适用于存放饮品、水果、高档西点等。

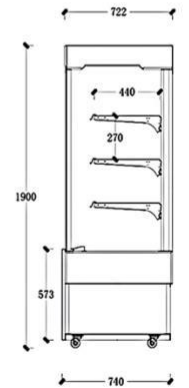

立式蛋糕柜CAD尺寸图

Holland
好利来

丹香
DanLex

达利园

合作伙伴

85°C
Daily Cafe

BreadTalk
面包新语

AILI®
爱的礼物



MODEL 型号	Dimensions: LxWxH (mm) 尺寸:长*宽*高 (mm)	Weight/net/ (gross) 净重/毛重 (Kg)	Voltage V/ph/Hz 电源 V/ph/Hz	Input power (W) 输入功率 (W)
12	1200*740*1900	135/152	220-240/1/50	620
15	1500*740*1900	160/180	220-240/1/50	890
18	1800*740*1900	200/225	220-240/1/50	990

双弧柜 RIGHT ANGLE CABINET



Ventilated
风冷循环

Defrosting
自动化霜

Efrigerant 134A
制冷剂 134A

Temperatur
工作温度 0-8°C

Climatic class/ RH%
工作温度 0-8°C

1. High power imported unit, Danfoss compressor, Shangfang temperature controller.
 2. Internal screw evaporator is used to increase heat exchange area and save energy and electricity;
Cover pole evaporation fan, all use hexagon screw, better fixation.
 3. The front and lower wall magnetic heat dissipation baffle is convenient to remove and clean the radiator, and the front and rear heat dissipation effect is better.
 4. Unique air cooling circulation system, the back wind makes the temperature of each layer uniform, and the back wind is due to the wind curtain
The barrier system only circulates in the cabinet and does not run air. Each shelf has a long air outlet.
- It is suitable for storing fruits, yoghurt, drinks, Western food and other refrigerated food.

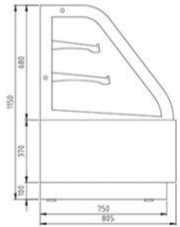

双弧柜CAD尺寸图

1. 大功率进口机组，丹弗斯压缩机，尚方温控器。
 2. 使用内螺纹蒸发器，增加换热面积，同时更节能省电；
罩极蒸发风机，全部使用六角螺丝，固定性更好。
 3. 前下围磁散热挡板，方便拆卸清理散热器，前后散热效果更佳。
 4. 独特的风冷循环系统，后背出风让每层温度均匀化，后背风因为风幕
阻隔系统只在柜内循环不跑风，每个层架都有长条出风口。
- 适用于存放水果、酸奶、饮料、西点等冷藏食品。

Holland
好利来

丹香
DanLex

达利园

合作伙伴

85°C
Daily
Coffee

BreadTalk
面包新语

AILI®
爱的礼物



MODEL 型号	Dimensions: L*W*H (mm) 尺寸:长*宽*高 (mm)	Weight(net)/ 净重/毛重 (Kg)	(gross) 电压 V/ph/Hz 电源 V/ph/Hz	Input power (W) 输入功率 (W)
12	1200*800*1200	160/180	220-240/1/50	360
15	1500*800*1200	170/190	220-240/1/50	400
18	1800*800*1200	180/200	220-240/1/50	450

DESKTOP

DISPLAY CABINET



台式蛋糕柜弧形 (黑/白)



- 1.前玻璃为双层夹胶电加热钢化玻璃, 夹胶玻璃设备, 机器代替人工, (同行业多为电热加热玻璃, 不进行夹胶处理, 这样导致加热不均匀, 电热丝容易下坠, 抖动, 从而影响安全与美观。夹胶处理不但可以解决这些问题还会成为安全玻璃, 并且可以隐藏电热丝)。
- 2.底座为烤漆板材质, 耐腐蚀。
- 3.冷风循环系统, 温度在2~8度。
- 4.采用尚方温控器.数字温控, 清晰可见, 更便捷。
- 5.冷凝风机采用铝扇叶, 耐高温, 不易变形, 不影响转速。
适用于存放水果、蛋糕、酸奶等。

1. The front glass is double-layer laminated electrically heated tempered glass, laminated glass equipment, machinery instead of manual, (most of the same industry are The glass is heated by electric heating without laminating treatment, which leads to uneven heating and easy falling and shaking of electric heating wire, So as to affect the safety and beauty. The sandwich treatment can not only solve these problems, but also become safety glass, and can To hide the heating wire).
2. The base is made of baking paint board, which is corrosion-resistant.
3. Cold air circulation system, the temperature is 2 ~ 8 degrees.
4. The use of Shang Fang thermostat. Digital temperature control, clear and visible, more convenient.
5. The condensing fan adopts aluminum fan blade, which is high temperature resistant , not easy to deform and does not affect the speed.
Suitable for storing fruits, cakes, yoghurt, etc.

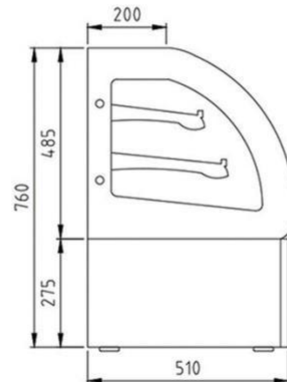

尺寸、颜色、制冷制热均可定做

型号 (Model)	规格 (MM)			功率(KW)	温度(°C)
	长 (L)	宽 (W)	高 (H)		
XMD-TH09	900	800	1100	0.21KW	2-8°C
XMD-TH12	1200	800	1100	0.26KW	2-8°C

台式蛋糕柜 直角 (黑/白)



1.前玻璃为双层夹胶电加热钢化玻璃, 夹胶玻璃设备, 机器代替人工, (同行业多为电热加热玻璃, 不进行夹胶处理, 这样导致加热不均匀, 电热丝容易下坠, 抖动, 从而影响安全与美观。夹胶处理不但可以解决这些问题还会成为安全玻璃, 并且可以隐藏电热丝)。

2.底座为烤漆板材质, 耐腐蚀。

3.冷风循环系统, 温度在2~8度。

4.采用尚方温控器.数字温控, 清晰可见, 更便捷。

5.冷凝风机采用铝扇叶, 耐高温, 不易变形, 不影响转速。

适用于存放水果、蛋糕、酸奶等。

1. The front glass is double-layer laminated electrically heated tempered glass, laminated glass equipment, machinery instead of manual, (most of the same industry are The glass is heated by electric heating without laminating treatment, which leads to uneven heating and easy falling and shaking of electric heating wire, So as to affect the safety and beauty. The sandwich treatment can not only solve these problems, but also become safety glass, and can To hide the heating wire).

2. The base is made of baking paint board, which is corrosion-resistant.

3. Cold air circulation system, the temperature is 2 ~ 8 degrees.

4. The use of Shang Fang thermostat. Digital temperature control, clear and visible, more convenient.

5. The condensing fan adopts aluminum fan blade, which is high temperature resistant , not easy to deform and does not affect the speed.

Suitable for storing fruits, cakes, yoghurt, etc.

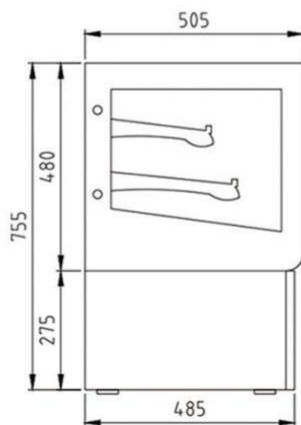

尺寸、颜色、制冷制热均可定做

型号 (Model)	规格 (MM)			功率(KW)	温度(°C)
	长 (L)	宽 (W)	高 (H)		
XMD-TZ09	900	800	1100	0.21KW	2-8°C
XMD-TZ12	1200	800	1100	0.26KW	2-8°C

罗森款台式柜

RED ARC FREEZER



1. Dongbei compressor, copper evaporator condenser, whole cabinet, double tempered glass hollow, front glass With demist, it is three-layer glass.
2. Cold air circulation system, the temperature is 2~8 degrees.
3. The use of Shang Fang thermostat. Digital temperature control, clear and visible, more convenient.
4. The condenser fan adopts aluminum fan blade, which is high temperature resistant, not easy to deform, and does not affect the speed. Suitable for storing fruits, cakes, etc.

- 1.东贝压缩机，全铜蒸发器冷凝器，整柜双层钢化玻璃中空，前玻璃带除雾，为三层玻璃。
- 2.冷风循环系统，温度在2~8度。
- 3.采用尚方温控器.数字温控，清晰可见，更便捷。
- 4.冷凝风机采用铝扇叶，耐高温，不易变形，不影响转速。适用于存放水果、蛋糕等。

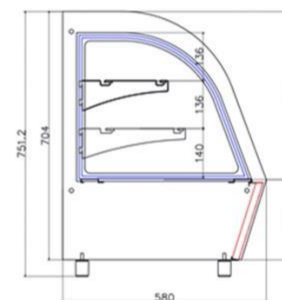

罗森款台式柜CAD尺寸图

合作伙伴

Holiland
好利来

丹香
DanLex

达利园

85°C
Daily
Cafe

BreadTalk
面包新语

AILI®
爱的礼物

MODEL 型号	Dimensions : LxWxH (mm) 尺寸:长*宽*高 (mm)	Weight(net)/ (gross) 净重/毛重 (Kg)	Voltage V/ph/Hz 电源 V/ph/Hz	Input power (W) 输入功率 (W)
07	700*588*700	135/152	220-240/1/50	330

Table type cake freezer

台式蛋糕柜



1. 东贝压缩机，全铜蒸发器冷凝器，整柜双层钢化玻璃中空，前玻璃带除雾，为三层玻璃。
2. 冷风循环系统，温度在2~8度。
3. 采用尚方温控器.数字温控，清晰可见，更便捷。
4. 冷凝风机采用铝扇叶，耐高温，不易变形，不影响转速。适用于存放水果、蛋糕等。

1. Dongbei compressor, copper evaporator condenser, whole cabinet, double tempered glass hollow, front glass With demist, it is three-layer glass.
2. Cold air circulation system, the temperature is 2 ~ 8 degrees.
3. The use of Shang Fang thermostat. Digital temperature control, clear and visible, more convenient.
4. The condenser fan adopts aluminum fan blade, which is high temperature resistant, not easy to deform, and does not affect the speed. Suitable for storing fruits, cakes, etc.

直角 freezer

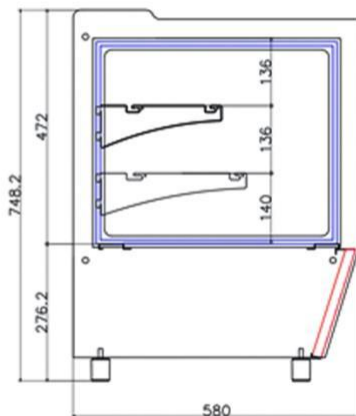
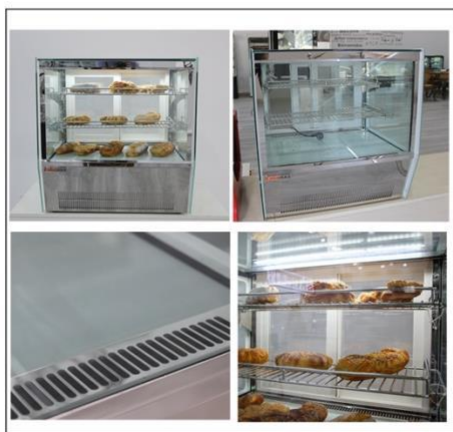

尺寸、颜色、制冷制热均可定做

型号 (Model)	规格 (MM)			功率(KW)	温度(°C)
	长 (L)	宽 (W)	高 (H)		
XMD-XTZ06	660	588	744	0.33KW	2-8°C
XMD-XTZ09	900	588	744	0.36KW	2-8°C
XMD-XTZ12	1200	588	744	0.40KW	2-8°C

红弧柜 RED ARC FREEZER



- Ventilated
风冷循环
- Defrosting
自动化霜
- Refrigerant 134A
制冷剂 134A
- Temperature
工作温度 0-8°C
- Climate class / RH
工作温度 0-8°C

1. Dongbei compressor, copper evaporator condenser, whole cabinet, double tempered glass hollow, front glass With demist, it is three-layer glass.
2. The front glass and side glass are all integrated glass, and the red shape of the side is environmental protection plastic profile, which is beautiful.
3. Cold air circulation system, the temperature is 2 ~ 8 degrees.
4. The use of Shang Fang thermostat. Digital temperature control, clear and visible, more convenient.
5. The condensing fan adopts aluminum fan blade, which is high temperature resistant, not easy to deform and does not affect the speed. Suitable for storing fruits, cakes, etc.

1. 东贝压缩机，全铜蒸发器冷凝器，整柜双层钢化玻璃中空，前玻璃带除雾，为三层玻璃。
2. 前玻璃和侧玻璃均为一体玻璃，侧面红色造型为环保塑料型材，造型美观。
3. 冷风循环系统，温度在2-8度。
4. 采用尚方温控器，数字温控，清晰可见，更便捷。
5. 冷凝风机采用铝扇叶，耐高温，不易变形，不影响转速。适用于存放水果、蛋糕等。

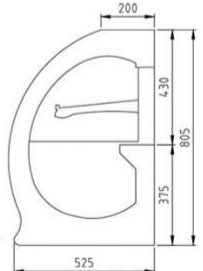

红弧柜CAD尺寸图

Holland
好利来

丹香
DanLex

达利园

合作伙伴

85°C
Daily
Cafe

BreadTalk
面包新语

AILI®
爱的礼物



MODEL 型号	Dimensions: L*W*H (mm) 尺寸: 长*宽*高 (mm)	Weight (net/ gross) 净重/毛重 (Kg)	Voltage V/ph/Hz 电源 V/ph/Hz	Input power (W) 输入功率 (W)
12	900*530*810	135/152	220-240/1/50	360
15	1200*530*810	160/180	220-240/1/50	400
18	1500*530*810	200/225	220-240/1/50	450

Table type cake 台式寿司柜



- 1.柜内恒温5℃，理想食品保鲜温度。
 - 2.倾斜式玻璃设计，增强食品展示效果。
 - 3.柜顶柜底同时制冷，冷却效果均匀，制冷能力稳定。
 - 4.底部倾斜+圆角设计，清洁更加方便。
 - 5.使用方便的开口高度为160mm,同时由于柜内没有直立的制冷管，柜内的容积得到了充分的利用。
- 适用于存放法式甜点、高端奶油蛋糕等。

1. The constant temperature in the cabinet is 5 °C, the ideal food preservation temperature.
 2. Inclined glass design to enhance the food display effect.
 3. The top and bottom of the cabinet are refrigerated at the same time, with uniform cooling effect and stable cooling capacity.
 4. Inclined bottom + round corner design, more convenient for cleaning.
 5. Convenient opening height is 160mm, and since there is no vertical refrigeration pipe in the cabinet, the volume of the cabinet is fully utilized.
- Suitable for storing French desserts, high-end cream cakes, etc.

freezer 弧形(黑/白)

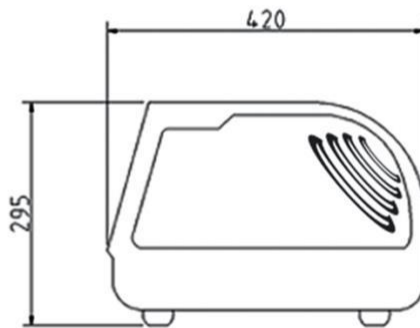
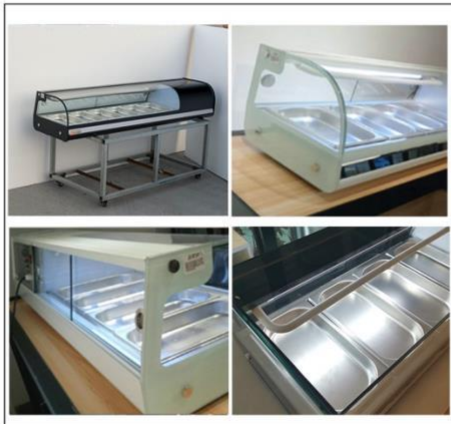

尺寸、颜色、制冷制热均可定做

型号 (Model)	规格 (MM)			功率(KW)	恒温(°C)
	长 (L)	宽 (W)	高 (H)		
XMD-SS4	1200	420	295	0.15KW	5°C
XMD-SS5	1200	420	295	0.15KW	5°C
XMD-SS6	1500	420	295	0.15KW	5°C
XMD-SS7	1800	420	295	0.15KW	5°C

Table type cake 台式寿司柜

直角(黑/白) freezer



- 1.柜内恒温5°C, 理想食品保鲜温度。
 - 2.倾斜式玻璃设计, 增强食品展示效果。
 - 3.柜顶柜底同时制冷, 冷却效果均匀, 制冷能力稳定。
 - 4.底部倾斜+圆角设计, 清洁更加方便。
 - 5.使用方便的开口高度为160mm,同时由于柜内没有直立的制冷管, 柜内的容积得到了充分的利用。
- 适用于存放法式甜点、高端奶油蛋糕等。

1. The constant temperature in the cabinet is 5 °C, the ideal food preservation temperature.
 2. Inclined glass design to enhance the food display effect.
 3. The top and bottom of the cabinet are refrigerated at the same time, with uniform cooling effect and stable cooling capacity.
 4. Inclined bottom + round corner design, more convenient for cleaning.
 5. Convenient opening height is 160mm, and since there is no vertical refrigeration pipe in the cabinet, the volume of the cabinet is To make full use of it.
- Suitable for storing French desserts, high-end cream cakes, etc.

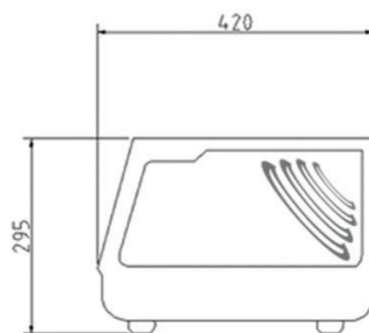

尺寸、颜色、制冷制热均可定做

型号 (Model)	规格 (MM)			功率(KW)	恒温(°C)
	长 (L)	宽 (W)	高 (H)		
XMD-SS4	1154	420	295	0.15KW	5°C
XMD-SS5	1330	420	295	0.15KW	5°C
XMD-SS6	1506	420	295	0.15KW	5°C
XMD-SS7	1680	420	295	0.15KW	5°C

商超生鲜便利店系列



SUPERMARKET FRESH CONVENIENCE STORE SERIES



便利店款风幕柜

 循环风道
Circulating air duct

 铜管制冷
Copper tube refrigeration

 工作温度2-8℃
Working temperature

多元化使用场景

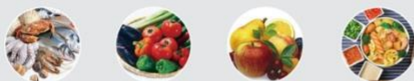

便利店款风幕柜特点:

1. 层架间距可自由调节, 承重力强。
 2. 保鲜夜幕帘采用慢回弹设计, 千百次的回弹测试, 结实耐用。
 3. 全新升级新配色, 高品质不锈钢材质。
 4. 循环风道-后背出风形成风幕防止冷气外泄。
 5. 全玻璃侧板, 双层加厚, 商品180°展示无死角。
 6. 高亮度LED节能灯管, 磁吸式安装, 方便移动拆卸。
- 适用于存放水果蔬菜、饮品等。



大型商超 果蔬店 自助餐厅 便利店

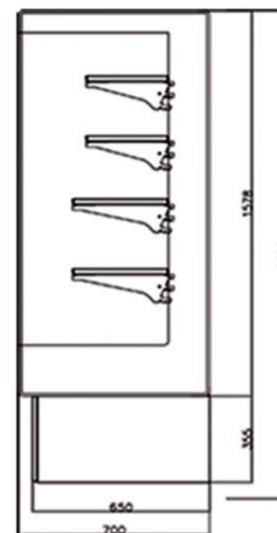

便利店款风幕柜CAD尺寸图 (异形定制)

Features of convenience store air curtain cabinet:

1. The space between layers can be adjusted freely and the bearing capacity is strong.
 2. The fresh-keeping night curtain adopts slow rebound design, and has been tested for thousands of times, which is strong and durable.
 3. New upgrade, new color, high quality stainless steel material.
 4. Circulating air duct - air curtain formed by back outlet to prevent leakage of cold air.
 5. All glass side plate, double thicken, 180° display without dead angle.
 6. High brightness LED energy saving lamp tube, magnetic suction installation, easy to remove.
- It is suitable for storing fruits, vegetables, drinks, etc.

尺寸、颜色、底座logo均可定做

型号 (Model)	规格 (MM)			功率(KW)	温度(℃)
	长 (L)	宽 (W)	高 (H)		
XMD-FM12	1200	700	2000	0.85KW	2-8℃
XMD-FM15	1500	700	2000	1.10KW	2-8℃
XMD-FM18	1800	700	2000	1.50KW	2-8℃

冷冻冷藏展示柜

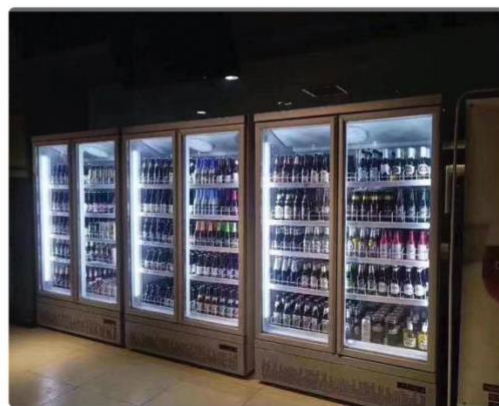

尺寸、冷藏冷冻均可定做

型号 (Model)	规格 (MM)			功率(冷藏/冷冻)	温度 (冷藏/冷冻)
	长 (L)	宽 (W)	高 (H)		
单门展示柜	650	700	2000	450/900KW	2-8°C/-18~-25°C
双门展示柜	1250	700	2000	750/1500KW	2-8°C/-18~-25°C
三门展示柜	1875	700	2000	950/1900KW	2-8°C/-18~-25°C

盒马敞开制冷/热柜



风冷循环
Air cooling cycle



自动加湿
Automatic humidification



工作温度2-8℃
Working temperature

多元化使用场景

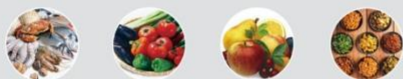

生鲜柜特点:

1. 上下双风道系统 (层架间距可自由调节)。
2. 四周采用超白高钢化玻璃, 食物清晰展示。
3. 冷凝风机铜线铜芯, 对比铝芯耐高温, 稳定性高, 成本高。
4. 小精灵温控器 (智能温控, 节能省电, 保鲜效果更好)。
5. 丹弗斯压缩机蒸发器, 冷凝器为内螺纹全铜管, 增大换热面积。适用于展示蔬菜水果、海鲜类食物等。



大型商超

果蔬店

自助餐厅

便利店

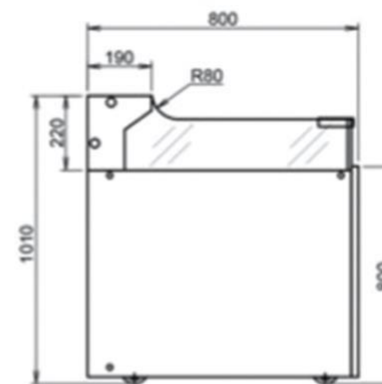

生鲜柜CAD尺寸图

Features of Fresh Cabinet:

1. Upper and lower air duct system (the space between layers can be adjusted freely).
2. Ultra white and high-definition tempered glass is used around, and food is clearly displayed.
3. Compared with aluminum core, copper core of condenser fan has high temperature resistance, high stability and high cost.
4. Shangfang temperature controller (intelligent temperature control, energy saving and power saving, better preservation effect).
5. The evaporator and condenser of Danfoss compressor are all copper tubes with internal thread to increase the heat exchange area.

It is suitable for displaying vegetables, fruits, seafood, etc.

尺寸、颜色、底座、logo、制冷制热均可定做

型号 (Model)	规格 (MM)			功率 (KW)	温度 (°C)
	长 (L)	宽 (W)	高 (H)		
XMD-SP12	1200	800	1010	0.72KW	2-8°C
XMD-SP15	1500	800	1010	0.80KW	2-8°C
XMD-SP18	1800	800	1010	0.87KW	2-8°C

卤食轻食展示柜

鸭脖 牛肉 串串 刺身 海鲜展示解决方案



弧形串串展示柜

ARC SERIES DISPLAY CABINET



1. Hermetic compressor. High refrigerating capacity, low consumption and low noise levels.
2. Automatic Inversion cycle defrost, fast defrosting time, that doesn't affect product characteristics.
3. Glasses: Safety double glass with Heating element, can work very well in high humidity environment.
4. Straight Front glass for the best visibility.
5. Colors are available upon your request.

1. 全封闭进口制冷压缩机组：全封闭压缩机 高效，低耗，低噪音。
2. 全自动逆循环化霜，不影响产品性能。
3. 玻璃：钢化风道除雾玻璃，适合高湿度的场所。
4. 弧面前玻璃使产品有更好的展示效果。
5. 颜色可根据要求定做。

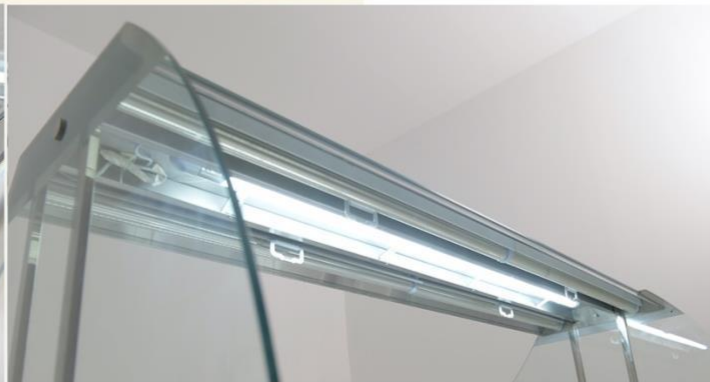
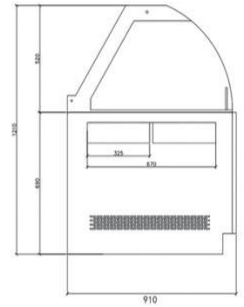

合作伙伴



型号	尺寸 (长*宽*高)	份数尺寸	份数盒深度	个数	下围高度
12	1200*880*1200	325*265	100/20	6	700
15	1500*880*1200	325*265	100/20	8	700
18	1800*880*1200	325*265	100/20	10	700
20	2000*880*1200	325*265	100/20	10	700
21	2100*880*1200	325*265	100/20	12	700
25	2500*880*1200	325*265	100/20	14	700

弧形鸭脖展示柜

RIGHT ANGLED DUCK NECK DISPLAY CABINET



Ventilated
风冷

Defrosting
自动化霜

Refrigerant: 134A
制冷剂 134A

Temperature
工作温度 0-8°C

Climatic class: ST/ST
气候温度/湿度 ST/ST5

1. Hermetic compressor: High refrigerating capacity, low consumption and low noise levels.
2. Automatic Inversion cycle defrost, fast defrosting time, that doesn't affect product characteristics.
3. Glasses: Safety double glass with Heating element, can work very well in high humidity environment.
4. Straight Front glass for the best visibility.
5. Colors are available upon your request.

1. 全封闭进口制冷压缩机组：全封闭压缩机 高效，低耗，低噪音。
2. 全自动逆循环化霜，不影响产品性能。
3. 玻璃：钢化风道除雾玻璃，适合高湿度的场所。
4. 弧面前玻璃使产品有更好的展示效果。
5. 颜色可根据要求定做。

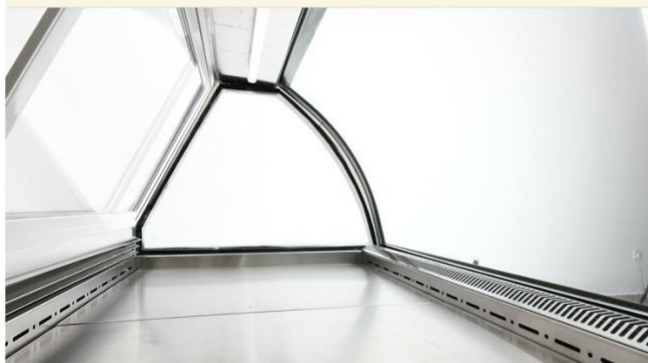
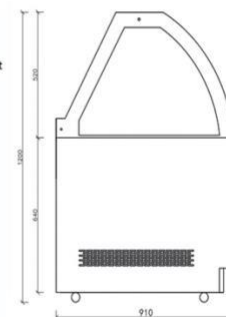

合作伙伴



MODEL 型号	Dimensions: LxWxH (mm) 尺寸: 长*宽*高 (mm)	Weight (net/ gross) 净重/毛重 (Kg)	Voltage V/ph/Hz 电源 V/ph/Hz	Input power (W) 输入功率 (W)
12	1200*910*1200	135/152	220-240/1/50	620
15	1500*910*1200	160/180	220-240/1/50	890
18	1800*910*1200	200/225	220-240/1/50	990

直角鸭脖展示柜

RIGHT ANGLED DUCK NECK DISPLAY CABINET



- Ventilated 风冷
- Defrosting 自动化霜
- Refrigerant 134A 制冷剂 134A
- Temperature 工作温度 0-8°C
- Climatic class 气候等级 RH% 环境温度/湿度 30/75

1. Hermetic compressor: High refrigerating capacity, low consumption and low noise levels.
2. Automatic Inversion cycle defrost, fast defrosting time, that doesn't affect product characteristics.
3. Glasses: Safety double glass with Heating element, can work very well in high humidity environment.
4. Straight Front glass for the best visibility.
5. Colors are available upon your request.

1. 全封闭进口制冷压缩机组：全封闭压缩机高效，低耗，低噪音。
2. 全自动逆循环化霜，不影响产品性能。
3. 玻璃：钢化风道除雾玻璃，适合高湿度的场所。
4. 平板式前玻璃使产品有更好的展示效果。
5. 颜色可根据要求定做。

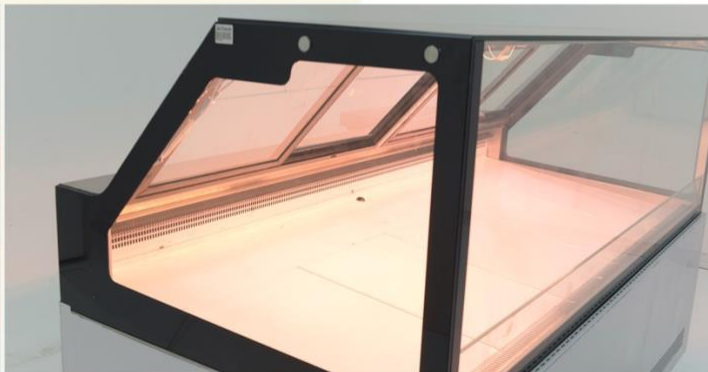
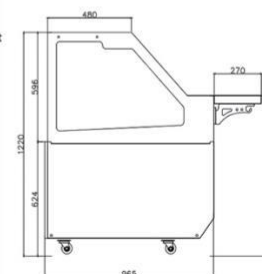

合作伙伴



MODEL 型号	Dimensions: LxWxH (mm) 尺寸: 长*宽*高 (mm)	Weight/net/ (gross) 净重/毛重 (Kg)	Voltage V/ph/Hz 电源 V/ph/Hz	Input power (W) 输入功率 (W)
12	1200*965*1220	135/152	220-240/1/50	620
15	1500*965*1220	160/180	220-240/1/50	890
18	1800*965*1220	200/225	220-240/1/50	990

前掀盖熟食柜

FRONT COVER COOKED FOOD CABINET



1. Curved glass design, enhance the display effect, frameless glass door, fashionable and beautiful.
 2. Large space storage, with single-layer shelf, to meet a variety of display needs.
 3. Cyclopentane is foamed as a whole, refrigerant R404A, with fast refrigeration speed and slow cooling.
 4. New upgrade, new color matching, high quality stainless steel plate.
 5. High power imported unit, Danfoss compressor, Shangfang thermostat.
- It is suitable for storing cooked food, duck neck, string and side dishes.

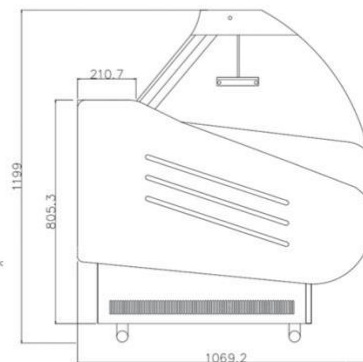

1. 弧面玻璃设计，增强展示效果，无边框玻璃门，时尚美观。
 2. 大空间储存，内有单层层架，满足多种展示需求。
 3. 环戊烷整体发泡，制冷剂R404A，制冷速度快，散冷慢。
 4. 全新升级新配色，高品质不锈钢板材。
 5. 大功率进口机组，丹弗斯压缩机，尚方温控器。
- 适用于存放熟食、鸭脖、串串、小菜等。

MODEL 型号	Dimensions : LxWxH (mm) 尺寸:长*宽*高 (mm)	Weight(net)/ 净重/毛重 (Kg)	(gross)	Voltage V/ph/Hz 电源 V/ph/Hz	Input power (W) 输入功率 (W)
12	1200*1070*1200	135/152		220-240/1/50	980
15	1500*1070*1200	160/180		220-240/1/50	1050
18	1800*1070*1200	200/225		220-240/1/50	1210

合作伙伴



小川料理

