

新品

材质：棉



SN0460 面团发酵布 600x1500mm  
SN0461 面团发酵布 750x1200mm

材质：0.075mm玻璃纤维涂层布



SN0470 不沾布 670x420mm  
SN0473 不沾布 580x380mm

新品

304不锈钢



SN3000 糖霜饰板-3个组

304不锈钢



V311 糖粉筛-大 直径100x220mm  
V310 糖粉筛-中 直径80x195mm  
V309 糖粉筛-小 直径70x185mm

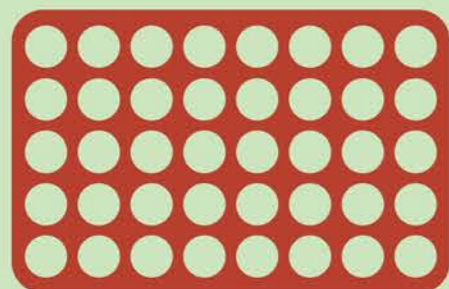

SN0561 硅胶  
40连圆型瓦片酥 570x370mm

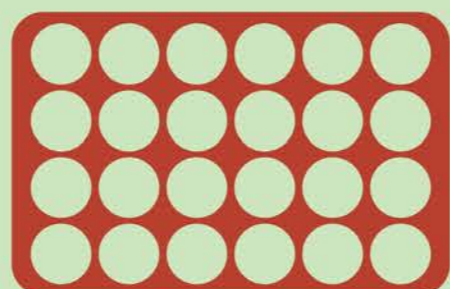

SN0562 硅胶  
24连圆型瓦片酥 570x370mm

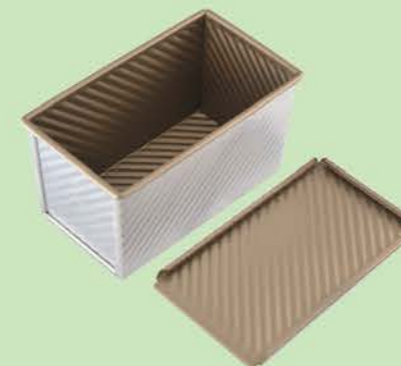

SN2089 1.0mm铝合金  
450g波纹土司盒(1000系列不沾) 内径196x106x110mm



SN2088 1.0mm铝合金  
450g波纹土司盒(1000系列不沾) 内径196x106x110mm

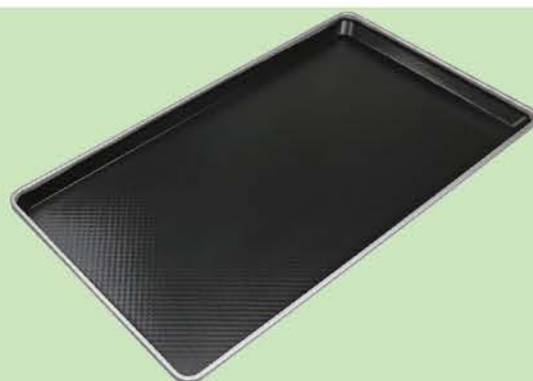

SN1285 0.7mm镀铝  
节能波纹镀铝烤盘(1000系列不沾) 720x400x30mm

3.0mm铝合金

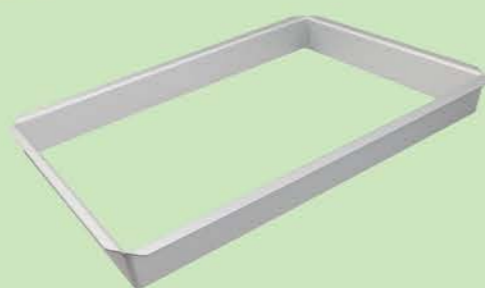

SN3397 长方圈(阳极) 540x280x60mm  
SN3398 长方圈(阳极) 470x240x60mm



SN2087 1.0mm铝合金  
450g土司盒(1000系列不沾) 内径196x106x110mm



SN2086 1.0mm铝合金  
250g土司盒(1000系列不沾) 内径160x94x77mm

新品



**SN2046** 0.8mm镀铝  
225g吐司盒(1000系列不沾) 内径180x100x62mm



**SN2175** 铝合金+镀铝  
半圆型吐司盒(1000系列不沾) 内径196x106x110mm



**SN2099** 1.0mm铝合金  
130g吐司盒-本体 (1000系列不沾) 内径141x81x48mm



**SN2100** 1.0mm铝合金  
245g吐司盒-本体 (1000系列不沾) 内径150x90x75mm



304不锈钢

- SN3166** 6cm法式塔圈 圆径60x20mm
- SN3168** 7cm法式塔圈 圆径70x20mm
- SN3170** 8cm法式塔圈 圆径80x20mm
- SN3172** 9cm法式塔圈 圆径90x20mm
- SN3173** 10cm法式塔圈 圆径100x20mm
- SN3174** 11cm法式塔圈 圆径110x20mm
- SN3175** 12cm法式塔圈 圆径120x20mm



1.0mm铝合金

- SN5770** 披萨盘-盖 6" 圆径180x10mm
- SN5771** 披萨盘-盖 7" 圆径206x10mm
- SN5772** 披萨盘-盖 8" 圆径230x10mm
- SN5773** 披萨盘-盖 9" 圆径258x10mm
- SN5774** 披萨盘-盖 10" 圆径284x10mm
- SN5776** 披萨盘-盖 12" 圆径333x10mm
- SN5777** 披萨盘-盖 15" 圆径405x10mm

新品



0.8mm镀铝

**SN6134** 爱心模(1000系列不沾) 100x60x25mm



0.8mm镀铝

**SN6137** 蝴蝶模(1000系列不沾) 76x54x25mm



**SN64265** 0.6mm铝合金  
小蛋糕模-猫爪5入(阳极) 71x52x40mm



**SN4270** 304不锈钢  
14" 不锈钢粉筛-10目 外径350x90mm



**SN5286** 1.0mm铝合金  
活动圆型空心布丁模(阳极) 130x114x80mm



PC塑料

**SN4686** 塑料冰铲-中 287x97mm  
**SN4685** 塑料冰铲-小 247x77mm

新品



不锈钢

**BG-GA-2**  
咖啡温度计 -10~100℃

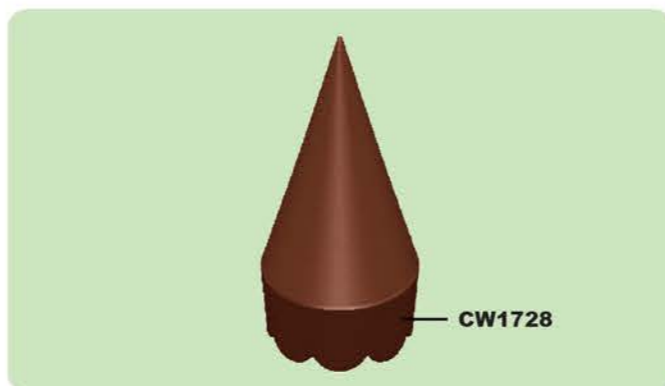

CW1728

**CW1728**  
巧克力模 275x135x40mm



0.4mm304不锈钢

**SN7017** 小型花嘴-12粒装



PE塑料

**7003** 21"塑料挤花袋-100入(绿色)  
530x280mm



PP塑料

**SN4652** 周转箱-本体(小) 640x410x90mm  
**SN4651** 周转箱-本体(大) 640x410x160mm  
**SN4650** 周转箱-盖 655x425x30mm

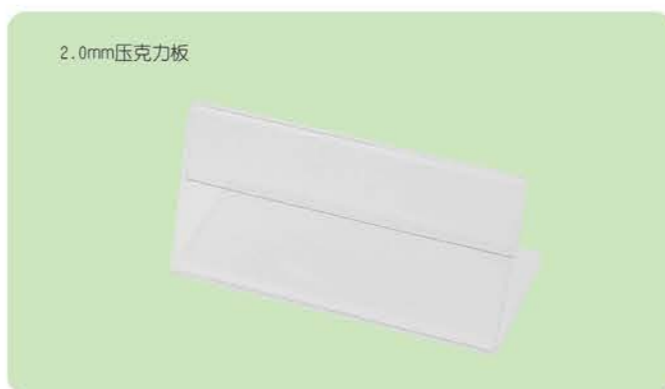

2.0mm压克力板

**SN85936** 标价夹-10入 80x35x39mm

新品



304不锈钢

破钢

破钢

**SN8649** 标价夹-黑色 底68x35mm 高100mm 斜度75°  
**SN8652** 标价夹-金铜色 底68x35mm 高100mm 斜度75°  
**SN8655** 标价夹-银色 底68x35mm 高100mm 斜度75°



304不锈钢

破钢

破钢

**SN8658** 标价夹-黑色 底68x35mm 高100mm 斜度75°  
**SN8661** 标价夹-金铜色 底68x35mm 高100mm 斜度75°  
**SN8664** 标价夹-银色 底68x35mm 高100mm 斜度75°



**SN7987** 14.5"耐热手套小-耐热220℃  
长度370mm (棉)



**SN7988** 14.5"耐热手套大-耐热220℃  
长度370mm (棉)



**SN7989** 17"耐热手套小-耐热220℃  
长度432mm (棉)



**SN7990** 17"耐热手套大-耐热220℃  
长度432mm (棉)



新品



(原SM2595499)

时间魔法套装

25.954.99.0065

圆径155x50mm

容积约: 600ml



(原SM2598887)

火光套装

25.988.87.0065

圆径240x85mm

容积约: 2000ml



钻石皇冠套装

25.985.87.0065

圆径240x75/206x40mm

容积约: 2000ml



龙尾套装

25.991.87.0065

圆径240x61/213x35mm

容积约: 2000ml



(原SM2599287)

交响乐套装

25.992.87.0065

圆径240x47mm

容积约: 1400ml



阴阳模

20.342.87.0065

252x150x50mm

容积约: 2500ml

新品



海妖之歌

25.995.99.0065

300x100x36mm

容积约: 1300ml



艾克雷亚

36.197.87.0065

295x190x35mm

中型129x40x35mm

容积约: 140ml



雪屋

36.201.87.0065

295x175x42mm

中型圆径76x42mm

容积约: 115ml



宝石-100ml

36.206.87.0065

295x175x30mm

中型61x61x30mm

容积约: 100ml



武士模

36.210.87.0065

300x175x35mm

中型圆径70x35mm

容积约: 110ml



方型模

36.216.87.0065

300x175x50mm

中型60x60x50mm

容积约: 150ml

新品



云朵模

20.341.87.0065

225x225x55mm  
容积约: 1600ml



正方体模

20.343.87.0065

175x175x50mm  
容积约: 1400ml



宝石-600ml

38.334.87.0065

132x132x40mm  
容积约: 600ml



宝石-1000ml

38.335.87.0065

160x160x50mm  
容积约: 1000ml



草莓模套装

28.310.87.0065

405x92x67mm  
中型圆径65x67mm  
容积约: 110ml



俄罗斯故事

28.311.87.0065

400x95x75mm  
单个圆径67x73mm  
容积约: 125ml

新品



链型方体模

32.147.87.0065

385x285x42mm  
中型375x42x42mm  
容积约: Tot 2000ml



链型三角模

32.148.87.0065

385x285x46mm  
中型375x46x51mm  
容积约: Tot 2000ml



25.073.99.0065

砖纹半圆模套装 295x127x73mm

33.073.20.0065

砖块模 250x185x6mm  
容积约: 1300ml



迷你心型模

36.227.87.0065

300x175x14mm  
中型23x25x13mm  
容积约: 5ml



迷你屋顶硅胶模

36.221.87.0065

300x175x15mm  
中型圆径26x14mm  
容积约: 5ml



迷你萨伐仑松饼模

36.222.87.0065

300x175x13mm  
中型圆径26x12mm  
容积约: 5ml

新品

新品



迷你椭圆模

**36.223.87.0065**  
300x175x13mm  
中型26 x19 x12mm  
容积约: 5ml



迷你圆型模

**36.224.87.0065**  
300x175x12mm  
中型圆径24 x12 mm  
容积约: 5ml



迷你方型模

**36.225.87.0065**  
300x175x14mm  
中型21x21x13mm  
容积约: 5ml



迷你石块模

**36.226.87.0065**  
300x175x14mm  
中型圆径26 x12mm  
容积约: 5ml



迷你宝石模

**36.228.87.0065**  
300x175x13mm  
中型23x23x13mm  
容积约: 5ml



小珍珠

**36.203.87.0065**  
300x175x6mm  
中型圆径7 h6mm  
容积约: 1ml



三角模

**70.462.20.0098**  
565x375x12mm  
中型36x38x12mm  
容积约: Tot 594ml



月牙模

**70.463.20.0098**  
566x372x13mm  
中型31x47x13mm  
容积约: Tot 684ml



小花模

**36.209.00.0060**  
300x175x40mm  
中型圆径75x40mm  
容积约: 100ml



8连长条模

**36.184.00.0065**  
265x26x16mm  
容积约: 40ml



鸡蛋硅胶模

**30.041.00.0060**  
295x175x36mm  
中型102x73x36mm  
容积约: 130ml



15连布丁模

**30.014.00.0060**  
295x175x15mm  
中型圆径50x15mm  
容积约: 25ml

001

017

020

028

036

042

050

058

064

072

080

090



001

## 节能波纹烤盘

铝合金/镀铝

专利号: ZL200620075116.2

### 更坚固

波纹工艺增加变形抗力, 更坚固耐用, 不易变形及撞伤; 比平面烤盘延长约1/3的使用寿命。

### 易脱模

冲压波纹后, 减少了烘焙产品与烤盘的接触面积, 更易脱模。

### 更美观

波纹纹理可增加烘焙产品美观性, 使烘焙产品更显质感。

### 省成本

有效缩短产品烘烤时间, 减少烘焙产品水份的流失, 在提升品质的同时达到节能的效果。

106

115

118

126

128

130

132

136

137

139

144

146

190

201

## 节能波纹铝合金烤盘



阳极

1.2mm铝合金

**SN1316** 节能波纹铝合金烤盘(阳极)  
600x400x25mm



1000系列不沾

**SN1317** 节能波纹铝合金烤盘(1000系列不沾)  
600x400x25mm

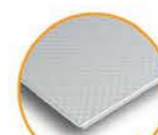

阳极

1.5mm铝合金

**SN1331** 节能波纹铝合金烤盘(阳极)  
600x400x20mm



1000系列不沾

**SN1332** 节能波纹铝合金烤盘(1000系列不沾)  
600x400x20mm



阳极

1.5mm铝合金

**SN1336** 节能波纹铝合金圆角烤盘(阳极)  
600x400x20mm



1000系列不沾

**SN1337** 节能波纹铝合金圆角烤盘(1000系列不沾)  
600x400x20mm

002

001

017

020

028

036

042

050

058

064

072

080

090

## 节能波纹铝合金烤盘



2000系列不沾涂层

1.2mm铝合金

**SN1356** 节能波纹铝合金烤盘(2000系列不沾)  
600x400x25mm

### 2000系列不沾

实验室测试数据,使用频次可达2000次以上  
注:一般不沾涂层烤盘平均使用频次在1000次左右。



反折压平工艺

1.2mm铝合金

**SN1313** 节能波纹铝合金烤盘(阳极)  
400x300x12mm

**SN1314** 节能波纹铝合金烤盘(1000系列不沾)  
400x300x12mm

### 反折压平工艺

四边采用反折压平工艺,使烤盘更坚固,四角可有效防止因撞击而导致凹陷或变形。

## 节能波纹镀铝烤盘



SN1271、SN1273

### 节能波纹镀铝烤盘 0.7mm镀铝

**SN1271** 600x400x30mm

**SN1273** 600x400x50mm

SN1272、SN1274

### 节能波纹镀铝烤盘(1000系列不沾) 0.7mm镀铝

**SN1272** 600x400x30mm

**SN1274** 600x400x50mm

SN1285



### 节能波纹镀铝烤盘(1000系列不沾) 0.7mm镀铝

**SN1285** 720x400x30mm

## 铝合金烤盘



SN1049

SN1050、SN1543

1.5mm铝合金

**SN1049** 铝合金圆角烤盘(阳极)  
600x400x20mm

**SN1050** 铝合金圆角烤盘(1000系列不沾)  
600x400x20mm

**SN1543** 铝合金圆角烤盘(3000系列不沾)  
600x400x20mm



SN1071

SN1072、SN1542

1.5mm铝合金

**SN1071** 铝合金烤盘(阳极)  
600x400x20mm

**SN1072** 铝合金烤盘(1000系列不沾)  
600x400x20mm

**SN1542** 铝合金烤盘(3000系列不沾)  
600x400x20mm



SN1527、SN1510、SN1532

SN1528、SN1541、SN1533

1.2mm铝合金

**SN1527** 铝合金烤盘(阳极) 600x400x25mm  
**SN1510** 铝合金烤盘 600x400x50mm

**SN1528** 铝合金烤盘(1000系列不沾) 600x400x25mm  
**SN1541** 铝合金烤盘(3000系列不沾) 600x400x25mm

1.0mm铝合金

**SN1532** 铝合金烤盘(阳极) 600x400x25mm  
**SN1533** 铝合金烤盘(1000系列不沾) 600x400x25mm

001

017

020

028

036

042

050

058

064

072

080

090

### 铝合金烤盘



SN1525、SN1534

**SN1525** 铝合金冲孔烤盘(阳极) 600x400x25mm  
**SN1526** 铝合金冲孔烤盘(1000系列不沾) 600x400x25mm

1.2mm铝合金

SN1526、SN1530

**SN1534** 铝合金冲孔烤盘(阳极) 600x400x25mm  
**SN1530** 铝合金冲孔烤盘(1000系列不沾) 600x400x25mm

1.0mm铝合金

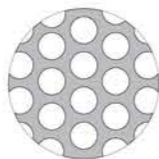

孔径3mm



反折压平工艺

1.5mm铝合金

**SN1048** 铝合金烤盘(1000系列不沾) 600x400x12mm

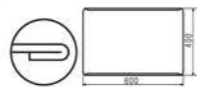

2.0mm铝合金

**SN1046** 铝合金烤盘(硬膜) 600x400x4mm

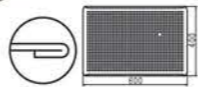

2.0mm铝合金

**SN1565** 铝合金冲孔冷却盘(硬膜) 600x400x4mm



1.5mm铝合金

**SN1070** 铝合金烤盘(2000系列不沾) 600x400x20mm



1.2mm铝合金

**SN1355** 铝合金烤盘(2000系列不沾) 600x400x25mm



1.5mm铝合金

**SN1051** 铝合金圆角烤盘(2000系列不沾) 600x400x20mm

106

115

118

126

128

130

132

136

137

139

144

146

190

201

### 镀铝烤盘



SN1077、SN1079  
SN1017

#### 标准型镀铝烤盘

0.7mm镀铝

**SN1077** 镀铝烤盘 600x400x30mm  
**SN1079** 镀铝烤盘 600x400x50mm  
**SN1017** 镀铝烤盘 718x460x25mm

SN1078、SN1069  
SN1080、SN1010、SN1361

**SN1078** 镀铝烤盘(1000系列不沾) 600x400x30mm  
**SN1069** 镀铝烤盘(1000系列不沾) 660x460x30mm  
**SN1080** 镀铝烤盘(1000系列不沾) 600x400x50mm  
**SN1010** 镀铝烤盘(1000系列不沾) 718x460x25mm  
**SN1361** 镀铝烤盘(2000系列不沾) 600x400x30mm



SN1535、SN1537

#### 经济型镀铝烤盘

0.6mm镀铝

**SN1535** 镀铝烤盘 600x400x30mm  
**SN1537** 镀铝烤盘 600x400x50mm

SN1536、SN1538

**SN1536** 镀铝烤盘(1000系列不沾) 600x400x30mm  
**SN1538** 镀铝烤盘(1000系列不沾) 660x400x50mm



001

017

020

028

036

042

050

058

064

072

080

090

106

115

118

126

128

130

132

136

137

139

144

146

190

201

## 铝合金家用烤盘



1.2mm铝合金

**SN1201** 铝合金烤盘(阳极)  
365x265x30mm



1.2mm铝合金

**SN1205** 铝合金烤盘(阳极)  
365x265x50mm



1.2mm铝合金

**SN1206** 铝合金烤盘(1000系列不沾)  
365x265x50mm



1.5mm铝合金

**SN1312** 铝合金方型烤盘(1000系列不沾)  
280x280x30mm



1.2mm铝合金

**SN1202** 铝合金烤盘(1000系列不沾)  
365x265x30mm

## 蜂蜜蛋糕木框



**SN1401** 蜂蜜蛋糕木框 白松木  
320x220x80mm



**SN1408** 蜂蜜蛋糕木框 白松木  
575x375x80mm



铝合金+白松木

**SN1405** 蜂蜜蛋糕模-下底含木框(阳极)  
680x580x80mm



铝合金+白松木

**SN1409** 蜂蜜蛋糕模-下底含木框(阳极)  
600x400x80mm



铝合金+镀铝

**SN1410** 蜂蜜蛋糕模-上盖(800系列不沾)  
600x400x61mm



SN1409、SN1410配套使用



## 方条烤盘

铝合金/镀铝

专利号：200820186351.6



烤盘堆叠图



烤盘的高度部分未完全喷涂，可避免烤盘堆叠时的摩擦。

### 增加强度

方条设计增加烤盘的强度和平整度，在烘烤及使用中烤盘不易产生扭曲及变形。

### 不易刮伤

不全高度喷涂处理工艺，使得烤盘在堆叠时不易刮伤烤盘表面的不沾处理层，从而保证产品品质。

### 不易倾斜

方条设计使烤盘堆叠时，有足够的强度支撑烤盘，且当堆叠过高时不易倾斜、不易倒塌。

### 避免重叠

方条烤盘在自动化生产线上，不会像包圆条的烤盘一样，使用时发生两片重叠。

## 镀铝方条烤盘



SN1084、SN1096  
SN1081、SN1087

SN1359、SN1085  
SN1097、SN1082、SN1088

0.7mm镀铝

- SN1084 镀铝方条烤盘 600x400x20mm
- SN1096 镀铝方条烤盘 600x400x25mm
- SN1081 镀铝方条烤盘 600x400x30mm
- SN1087 镀铝方条烤盘 600x400x50mm

- SN1085 镀铝方条烤盘(1000系列不沾) 600x400x20mm
- SN1097 镀铝方条烤盘(1000系列不沾) 600x400x25mm
- SN1082 镀铝方条烤盘(1000系列不沾) 600x400x30mm
- SN1088 镀铝方条烤盘(1000系列不沾) 600x400x50mm

- SN1359 镀铝方条烤盘(2000系列不沾) 600x400x30mm

## 铝合金方条烤盘



SN1091

SN1092、SN1351

1.2mm铝合金

- SN1091 铝合金方条烤盘(阳极) 600x400x20mm

- SN1092 铝合金方条烤盘(1000系列不沾) 600x400x20mm

- SN1351 铝合金方条烤盘(2000系列不沾) 600x400x20mm

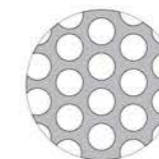

孔径3mm

1.2mm铝合金

- SN1093 铝合金冲孔方条烤盘(阳极) 600x400x20mm

## 汉堡烤盘

### 汉堡烤盘

#### 外形美观 大小统一的汉堡

使用汉堡烤盘，烤出外形美观、大小统一的汉堡面包、三明治面包、餐包等。



**注意**  
在选购汉堡烤盘时，请注意汉堡中型距边尺寸与台车水平隔板间距尺寸是否匹配以保证放置平面、平正。  
例：SN1616 SN1618 SN1643与SN1992 SN1996 SN1971不匹配。

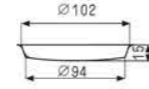

专利号码:200820186351.6

0.8mm镀铝

**SN1620** 4"15连弧型方条汉堡烤盘(1000系列不沾)  
600x400x40mm

## 汉堡烤盘

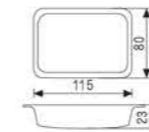

0.8mm镀铝

**SN1651** 12连方型汉堡烤盘(1000系列不沾)  
600x400x48mm

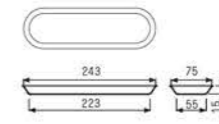

0.8mm镀铝

**SN1640** 8连长条面包烤盘(1000系列不沾)  
600x400x40mm

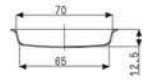

0.8mm镀铝

**SN1612** 2.8"24连弧型汉堡烤盘(1000系列不沾)  
600x400x38mm

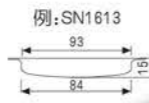

0.8mm镀铝

例:SN1613  
**SN1613** 3.5"15连弧型汉堡烤盘(1000系列不沾) 600x400x40mm  
**SN1615** 4"15连弧型汉堡烤盘(1000系列不沾) 600x400x40mm  
**SN1618** 4"15连弧型汉堡烤盘(1000系列不沾) 600x400x40mm

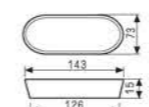

0.8mm镀铝

**SN1643** 12连长条面包烤盘(1000系列不沾)  
600x400x40mm

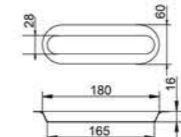

0.8mm镀铝

**SN1644** 15连长条面包烤盘(1000系列不沾)  
600x400x40mm

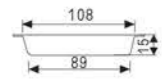

0.8mm镀铝

**SN1616** 4"15连平底汉堡烤盘(1000系列不沾)  
600x400x40mm

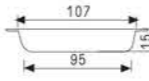

0.8mm镀铝

**SN1617** 4"12连平底汉堡烤盘(1000系列不沾)  
600x400x40mm



304不锈钢

**SN9141** 15连蒸蛋糕模  
600x400x45mm

001

017

020

028

036

042

050

058

064

072

080

090

106

115

118

126

128

130

132

136

137

139

144

146

190

201

## 法国烤盘



铝合金

**SN1586** 4槽法国烤盘(1000系列不沾)  
600x400x39/86x24mm

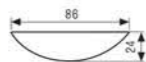

铝合金

**SN1587** 5槽法国烤盘(1000系列不沾)  
600x400x39/66x25mm

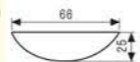

铝合金

5槽法国烤盘(1000系列不沾)

**SN1593** 660x460x33/86x24mm  
**SN1595** 600x400x33/66x25mm

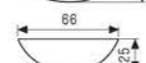
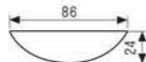

铝合金

4槽法国烤盘(1000系列不沾)

**SN1594** 600x400x33/86x24mm  
**SN1596** 600x400x33/75x24x26mm

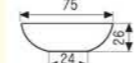

## 平网盘



304不锈钢

**SN1570** 不锈钢网盘  
600x400x25mm



304不锈钢

**SN1573** 不锈钢平网盘  
720x460x8mm



304不锈钢

**SN1575** 不锈钢平网盘  
600x400x8mm

## 不沾布



0.13mm玻璃纤维涂层布

**SN0475** 不沾布 275x245mm  
**SN0487** 不沾布 580x380mm  
**SN0488** 不沾布 670x420mm



材质: 0.075mm玻璃纤维涂层布

**SN0470** 不沾布 670x420mm  
**SN0473** 不沾布 580x380mm

001

017

020

028

036

042

050

058

064

072

080

090

不沾布、蒸笼垫

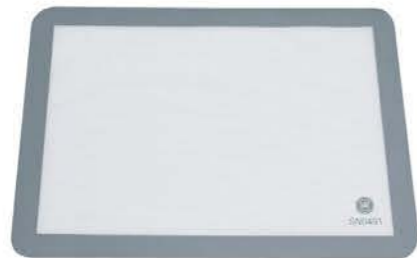

SN0491 硅胶不沾布-白色  
570x370mm



SN0492 硅胶不沾布-红色  
595x395mm



规格可定制  
SN0495 硅胶蒸笼垫  
570x370mm



材质: 棉  
SN0460 面团发酵布 600x1500mm  
SN0461 面团发酵布 750x1200mm

瓦片酥&达克瓦兹

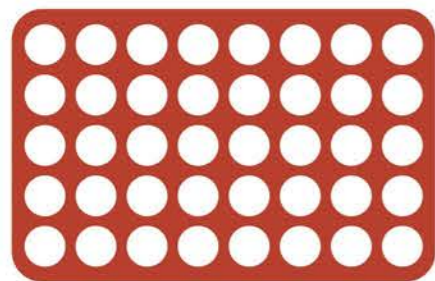

硅胶  
SN0561 40连圆型瓦片酥  
570x370mm

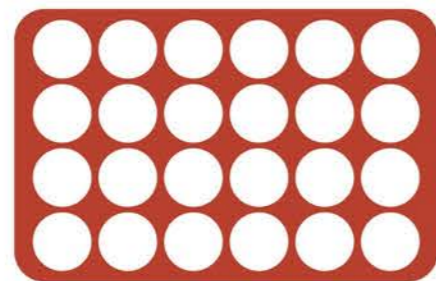

硅胶  
SN0562 24连圆型瓦片酥  
570x370mm



PC塑料  
SN0511 12连椭圆达克瓦兹模  
340x190mm 单个45x70mm

106

115

118

126

128

130

132

136

137

139

144

146

190

201

蛋糕网模 1.0mmPVC塑料 规格: 600x400mm

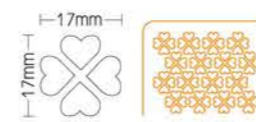

SN0523 心型蛋糕网模

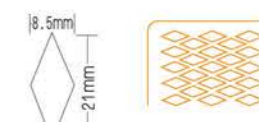

SN0543 菱型蛋糕网模



SN0528 树型蛋糕网模



SN0548 三角型蛋糕网模



SN0533 方型蛋糕网模



SN0553 长条型蛋糕网模

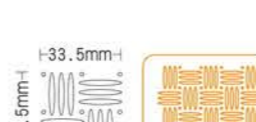

SN0538 网型蛋糕网模



SN0558 异型蛋糕网模



网模采用PVC材料制成, 不耐高温, 只能用冷水或温水清洗, 否则会因高温变形而影响以后的使用。



将蛋糕网盘置于不沾布上, 倒入原料并用刮刀刮平, 即可拿起蛋糕网模。



将已刮好原料图案的不沾布冷藏1-2小时后原料图案会更定型, 即可平放于烤盘内(原料图案向上), 倒入蛋糕原料用弯型刮平刀抹平。



原料抹平后, 放进烤箱内, 烘烤完成取出并倒出面皮, 将不沾布拿起, 即完成高级花样面皮。



用轮刀或刀具切割所需规格尺寸装饰蛋糕。



工具系列	其他工具系列	蛋糕转台系列	打蛋盆打蛋器系列	烙印模系列	新娘花系列	蛋糕塔系列	挤花袋系列	ONEWAY系列	花瓣系列	面杆系列	SILKOMART系列	WORLD系列	CHOCOLATE	巧克力模具系列
106	115	118	126	128	130	132	136	137	139	144	146	190	201	

### 多连式烤盘 镀铝



**SN9059** 15连麦芬盘(1000系列不沾)  
600x400x54mm

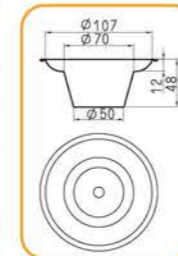

**SN9075** 40连蛋挞模(1000系列不沾)  
600x400x20mm 全包式

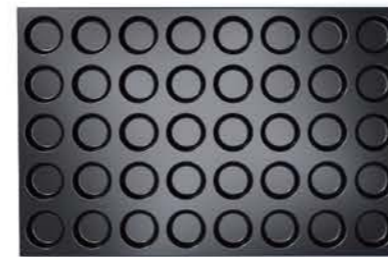
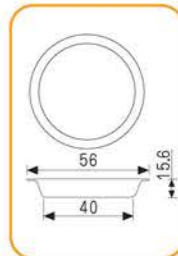

**SN9057** 40连圆型模(1000系列不沾)  
600x400x20mm

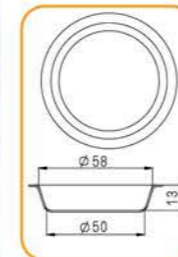

**SN9058** 40连肉松盘(1000系列不沾)  
593x393x24mm

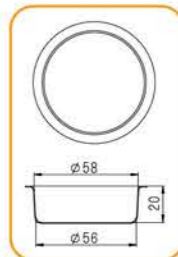

**SN9222** 15连大圆模(800系列不沾)  
600x400x39mm 全包式

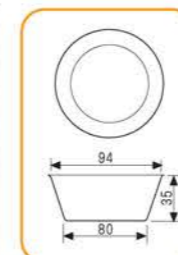

**SN9083** 24连布丁模(800系列不沾)  
600x400x39mm 全包式

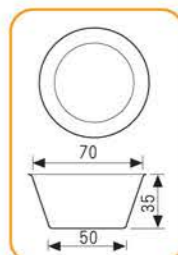

**SN9084** 28连布丁模(800系列不沾)  
600x400x34mm 全包式

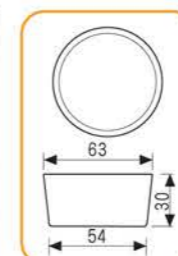

**SN9088** 35连布丁模(800系列不沾)  
600x400x32mm 全包式

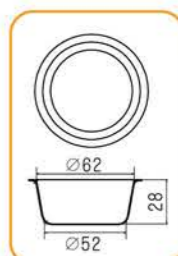

多连式烤盘 镀铝

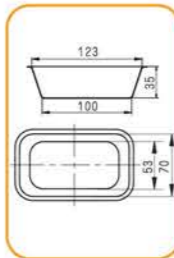

SN9090 16连雪方蛋糕模(1000系列不沾)  
600x400x39mm

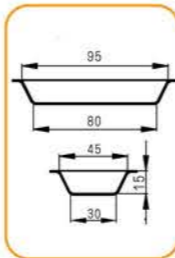

SN9037 30连长方形型模(800系列不沾)  
600x400x19mm 全包式

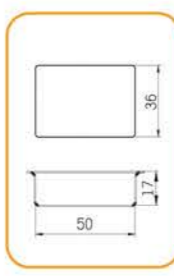
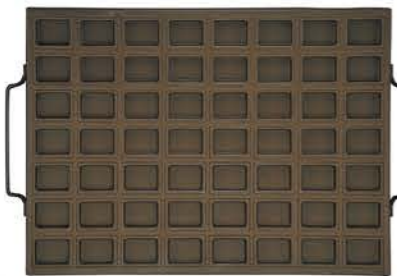

SN9060 56连凤梨酥模(1000系列不沾)  
616x400x26mm(含盖)

建议克重: 28g

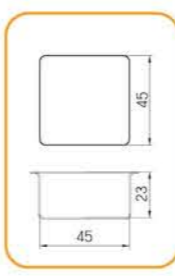

SN9070 48连凤梨酥模(1000系列不沾)  
616x400x26mm(含盖)

建议克重: 45g

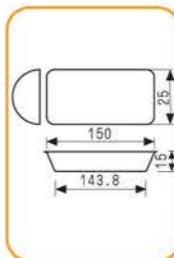

SN9039 24连长方形型模(800系列不沾)  
600x400x19mm

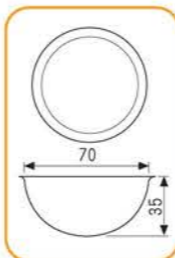

SN9102 24连浅半圆模(800系列不沾)  
600x400x39mm

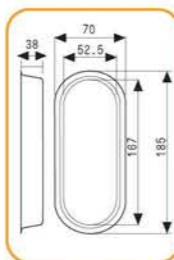

SN9051 12连长条型模(800系列不沾)  
SN9054 12连长条型模(1000系列不沾)  
规格: 600x400x42mm

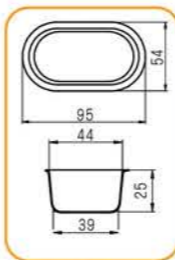
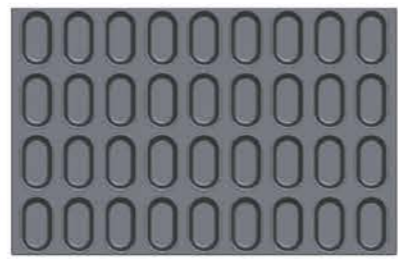

SN9089 36连磨堡模(1000系列不沾)  
600x400x26mm 反扣式

全新反扣工艺,  
易清洁、不滴油

多连式烤盘 镀铝

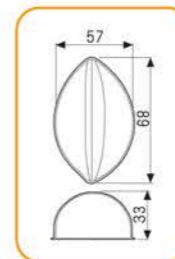

SN9021 28连柠檬模(800系列不沾)  
600x400x37mm

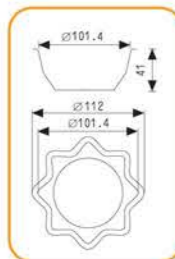

SN9424 15连星型模(1000系列不沾)  
600x400x45mm

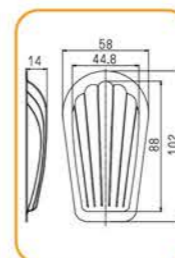

SN9040 24连贝壳模(800系列不沾)  
600x400x25mm

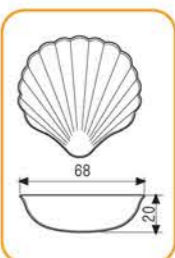

SN9042 24连贝壳模(800系列不沾)  
600x400x24mm

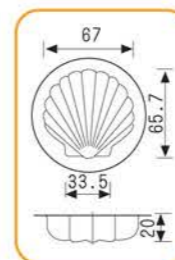
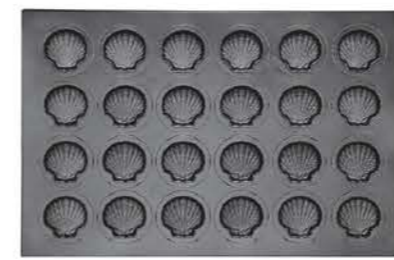

SN9044 24连深贝壳模(800系列不沾)  
600x400x24mm

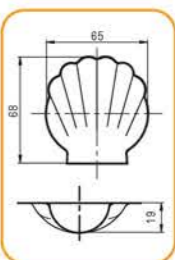

SN9035 28连贝壳模(800系列不沾)  
600x400x23mm

### 多连式烤盘 镀铝

● 不沾产品切勿使用高温蒸气清洗及蒸煮，否则易造成不沾层起皮脱落。



**SN9213** 24连心型模(800系列不沾)  
600x400x29mm

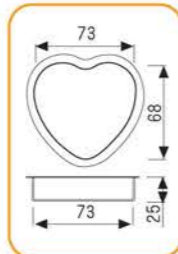

**SN9214** 54连心型模(800系列不沾)  
600x400x24mm

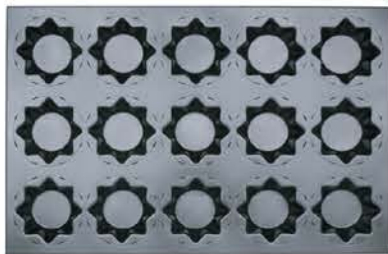
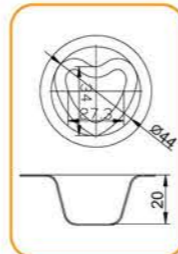

**SN9423** 15连星型模(800系列不沾)

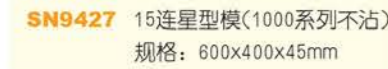

**SN9427** 15连星型模(1000系列不沾)  
规格: 600x400x45mm

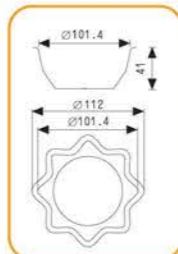

**SN9604** 20连小鸭模(800系列不沾)  
600x400x32mm

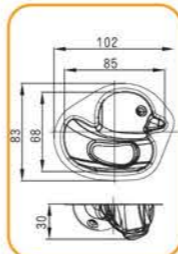

**SN9093** 40连空心圆模(800系列不沾)  
600x400x20mm

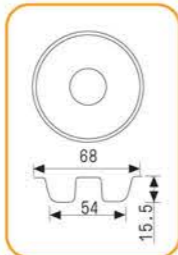

**SN9607** 25连胡萝卜模(800系列不沾)  
600x400x25mm

(专利号码: 201430554257.2)

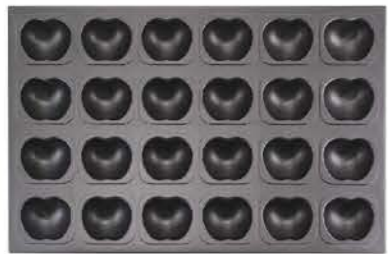
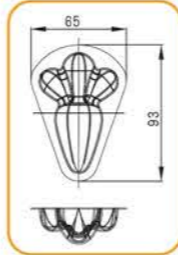

**SN9606** 24连苹果模(800系列不沾)  
600x400x40mm

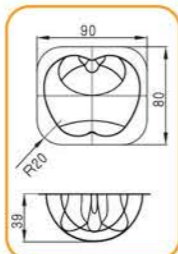

**SN9130** 32连爱心小猪模(800系列不沾)  
600x400x27mm

(专利号码: 201130396327.2)

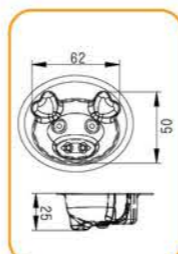

### 多连式烤盘 镀铝



**SN9608** 24连小猴模(800系列不沾)  
600x400x27mm

(专利号码: 201430554453.X)

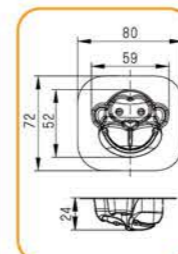

**SN9092** 25连熊猫模(800系列不沾)  
600x400x32mm

(专利号码: 201130396325.3)



**SN9087** 12连布丁模(800系列不沾)  
365x265x30mm



**SN9047** 11连深贝壳模(800系列不沾)  
365x265x20mm



**SN9023** 28连桃型模(800系列不沾)  
600x400x40mm

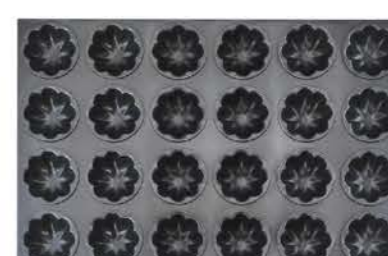
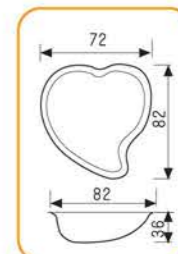

**SN9056** 24连梅花模(800系列不沾)  
600x400x34mm

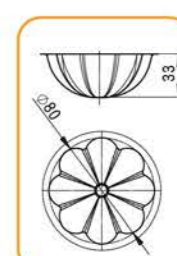

1.0mm铝合金

**SN9048** 10连贝壳模(800系列不沾)  
328x198x20mm



**SN9033** 12连猫爪模(800系列不沾)  
365x265x22mm

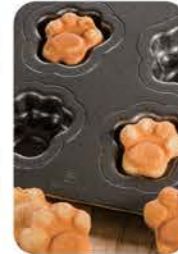

001

017

020

028

036

042

050

058

064

072

080

090

106

115

118

126

128

130

132

136

137

139

144

146

190

201

多连式烤盘 镀铝



SN9121 12连木瓜模(800系列不沾)  
600x400x52mm 全包式

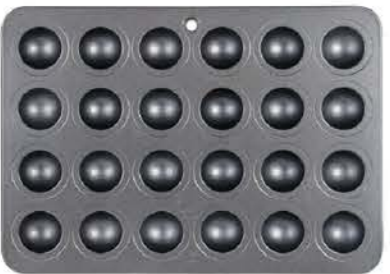

SN9107 24连小圆模(800系列不沾)  
365x265x25mm



SN9030 10连贝壳模(800系列不沾)  
365x265x17mm



SN9086 11连布丁模(800系列不沾)  
365x265x36mm



SN9106 11连浅半圆模(800系列不沾)  
365x265x35mm



SN9029 8连长方形型模(800系列不沾)  
365x265x16mm



SN9026 9连柠檬模(800系列不沾)  
365x265x33mm



SN9046 11连贝壳模(800系列不沾)  
365x265x20mm

多连式烤盘 镀铝



SN9108 4连足球模(1000系列不沾)  
400x135x90mm

(专利号码: 201420806031.1)



SN9110 4连排球模(1000系列不沾)  
400x135x90mm



SN9112 3连车轮模(1000系列不沾)  
315x280x80mm

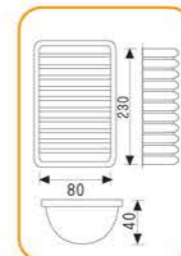
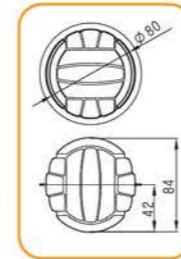
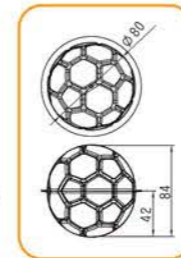

SN9109 4连篮球模(1000系列不沾)  
400x135x90mm



SN9011 6连炸弹食品模(1000系列不沾)  
615x197x98mm



SN9116 6连车轮模(1000系列不沾)  
615x197x98mm



SN9117 6连元宝模(1000系列不沾)  
615x211x107mm

(专利号码: 201130396326.6)

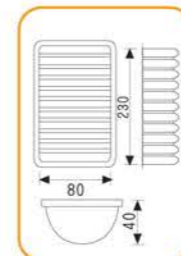
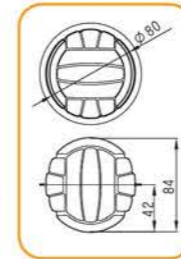
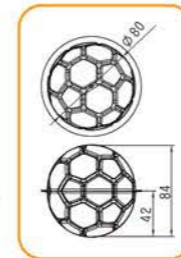



工具系列	其他工具系列	蛋糕转台系列	打蛋盆打蛋器系列	烙印模系列	新娘花系列	蛋糕培系列	挤花袋系列	ONEWAY系列	花瓣系列	面杆系列	SILKOMART系列	WORLD系列	CHOCOLATE	巧克力模具系列
106	115	118	126	128	130	132	136	137	139	144	146	190	201	

## 土司盒

不沾产品切勿使用高温蒸气清洗及蒸煮，否则易造成不沾层起皮脱落。

### 面团克重自测方法参考

先盛满水，倒出后称出水的重量。若是做蛋糕就用水重除以3；若是做面包就用水重除以4，所得出的数字即为该模具的基本克重。



1500g土司盒	1.0mm铝合金
<b>SN2000</b>	1500g土司盒(1000系列不沾) 内径450x128x130mm

1200g土司盒	内径370x120x125mm
<b>SN2001</b>	1200g土司盒(2000系列不沾)
<b>SN2004</b>	1200g土司盒(1000系列不沾) 1.0mm铝合金
<b>SN2201</b>	1200g土司盒(1000系列不沾+盖硬膜) 1.1mm铝合金

1000g土司盒	内径327x121x121mm
<b>SN2017</b>	1000g土司盒(2000系列不沾)
<b>SN2012</b>	1000g土司盒(1000系列不沾) 1.0mm铝合金
<b>SN2206</b>	1000g土司盒(1000系列不沾+盖硬膜) 1.1mm铝合金

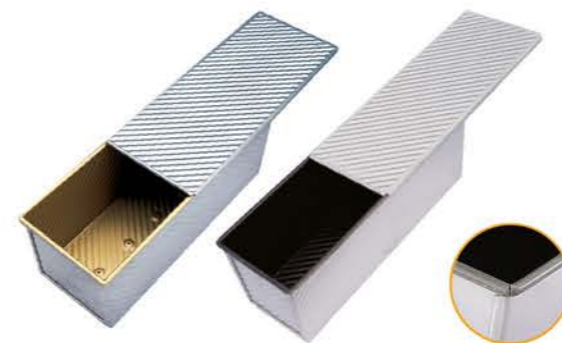

专利号码: 200720042534.6

1200g土司盒	内径370x120x125mm
<b>SN2006</b>	1200g波纹土司盒(1000系列不沾)
<b>SN2007</b>	1200g波纹土司盒(1000系列不沾) 1.0mm铝合金

1000g土司盒	1.0mm铝合金
<b>SN2015</b>	1000g波纹土司盒(1000系列不沾) 内径327x121x121mm



1000g土司盒	铝合金
<b>SN2906</b>	1000g3连土司盒(1000系列不沾) 505x340x124mm
<b>SN2897</b>	900g4连土司盒(1000系列不沾) 595x340x125mm

## 土司盒

专利号码: 200720042534.6

900g土司盒 1.0mm铝合金

**SN2025** 900g波纹土司盒(1000系列不沾) 内径325x107x120mm

900g土司盒

**SN2027** 900g土司盒(2000系列不沾) 内径325x106x122mm 1.0mm铝合金

**SN2022** 900g土司盒(1000系列不沾) 内径325x107x120mm 1.0mm铝合金

**SN2211** 900g土司盒(1000系列不沾) 内径325x106x122mm 1.1mm铝合金

1.0mm铝合金

**SN2032** 750g土司盒(1000系列不沾) 内径316x100x116mm

**SN2042** 600g土司盒(1000系列不沾) 内径309x91x107mm



专利号码: 200720042534.6

1.0mm铝合金

**SN2054** 450g波纹吐司盒-本体(1000系列不沾) 内径196x106x110mm

**SN20542** 450g波纹吐司盒-盖(1000系列不沾) 214x123x13mm



**SN2089** 450g波纹吐司盒(1000系列不沾) 内径196x106x110mm



专利号码: 200720042534.6

1.0mm铝合金

**SN2055** 450g波纹吐司盒-本体(1000系列不沾) 内径196x106x110mm

**SN20552** 450g波纹吐司盒-盖(1000系列不沾) 214x123x13mm



**SN2088** 450g波纹吐司盒(1000系列不沾) 内径196x106x110mm



SN2054与SN2052的产品效果不同, 因SN2045一体抽型, R角大, 所以不适合切片土司。

0.8mm镀铝

**SN2045** 450g波纹吐司盒-本体(1000系列不沾) 内径196x106x110mm

**SN20452** 450g波纹吐司盒-盖(1000系列不沾) 214x121x13mm

## 土司盒

一体成型专利设计, 四角补强, 更坚固耐用;  
无缝设计, 不藏污垢,  
易清洁



专利号码: ZL200430016051.0

1.0mm铝合金

**SN2057** 450g折叠式吐司盒-本体(1000系列不沾) 内径196x106x110mm



1.0mm铝合金

**SN2047** 450g吐司盒(2000系列不沾) 内径196x106x110mm



1.0mm铝合金

**SN2052** 450g吐司盒-本体(1000系列不沾) 内径196x106x110mm

**SN20522** 450g吐司盒-盖(1000系列不沾) 214x122x13mm



**SN2087** 450g吐司盒(1000系列不沾) 内径196x106x110mm



1.0mm铝合金

**SN2085** 250g吐司盒-本体(1000系列不沾) 内径160x94x77mm

**SN20852** 250g吐司盒-盖(1000系列不沾) 182x112x13mm



**SN2086** 250g吐司盒(1000系列不沾) 内径160x94x77mm



1.0mm铝合金

**SN2083** 385g波纹吐司盒(1000系列不沾) 内径217x94x77mm



1.0mm铝合金

**SN2082** 385g吐司盒-本体(1000系列不沾) 内径217x94x77mm

**SN20822** 385g吐司盒-盖(1000系列不沾) 237x112x13mm

001

017

020

028

036

042

050

058

064

072

080

090

土司盒 1.0mm铝合金



建议克重320g

SN2092 土司盒(1000系列不沾) 内径180x120x55mm



金条

SN2093 土司盒(1000系列不沾) 内径180x60x60mm



维也纳

SN2094 土司盒(1000系列不沾) 内径177x60x92mm



迷你维也纳

SN2095 土司盒(1000系列不沾) 内径118x60x92mm



SN2097 土司盒(1000系列不沾) 内径160x96x76mm



SN2098 土司盒-本体(1000系列不沾) 内径197x100x95mm



SN2099 130g土司盒-本体(1000系列不沾) 内径141x81x48mm



SN2100 245g土司盒-本体(1000系列不沾) 内径150x90x75mm

106

115

118

126

128

130

132

136

137

139

144

146

190

201

土司盒 1.0mm铝合金



SN2124 水果条(1000系列不沾) 内径268x95x80mm



龙背

SN2127 水果条(1000系列不沾) 内径254x84x55mm



SN2073 水果条(阳极) 内径100x56x34mm

SN2131 水果条(1000系列不沾) 内径100x56x34mm



SN2072 水果条(阳极) 内径128x66x40mm

SN2130 水果条(1000系列不沾) 内径128x66x40mm



0.6mm铝合金

SN2071 水果条 内径151x67x67mm

SN2129 水果条(1000系列不沾) 内径151x67x67mm/140x58mm



SN2070 水果条(阳极) 内径175x85x70mm

SN2128 水果条(1000系列不沾) 内径175x85x70mm



SN2074 水果条(阳极) 内径151x67x66mm

SN2121 水果条(800系列不沾) 内径151x67x66mm



SN2132 水果条(1000系列不沾) 内径230x50x65mm

SN2075 水果条(阳极) 内径240x77x62mm

SN2133 水果条(1000系列不沾) 内径240x77x62mm

001

017

020

028

036

042

050

058

064

072

080

090

## 土司盒



0.8mm 镀铝



**SN2046** 225g土司盒(1000系列不沾)  
内径180x100x62mm



铝合金+镀铝



**SN2175** 半圆型土司盒(1000系列不沾)  
内径196x106x110mm



1.0mm 铝合金

**SN2185** 正方形土司盒-本体(1000系列不沾)  
内径50x50x50mm



1.0mm 铝合金

**SN2096** 土司盒(1000系列不沾)  
内径85x85x73mm



1.8mm 铝合金

**SN2176** 圆柱型土司盒(1000系列不沾)  
内圆径100x100mm

↓ 可与以下正方形土司盒配合使用



1.0mm 铝合金

**SN2179** 正方形土司盒(1000系列不沾) 内径60x60x60mm  
**SN2180** 正方形土司盒(1000系列不沾) 内径75x75x75mm  
**SN2181** 正方形土司盒(1000系列不沾) 内径100x100x50mm  
**SN2182** 正方形土司盒(1000系列不沾) 内径100x100x100mm  
**SN2183** 正方形波纹土司盒(1000系列不沾) 内径100x100x100mm



## 土司盒



建议克重400g  
专利号码: ZL200530133333.3 铝合金

**SN2303** 圆土司盒(1000系列不沾)  
内圆径83x287mm



建议克重1000g  
专利号码: ZL200530133332.9 铝合金

**SN2304** 圆土司盒(1000系列不沾)  
内圆径120x331mm



建议克重1200g 1.0mm 镀铝

**SN2305** 波纹圆土司盒(1000系列不沾)  
圆径124x227mm



建议克重350g 铝合金

**SN2306** 梅花型土司盒(1000系列不沾)  
内径250x100x92mm



建议克重300g  
专利号码: 201130454684.X 铝合金

**SN2307** 心型土司盒(1000系列不沾)  
内径250x105x99mm

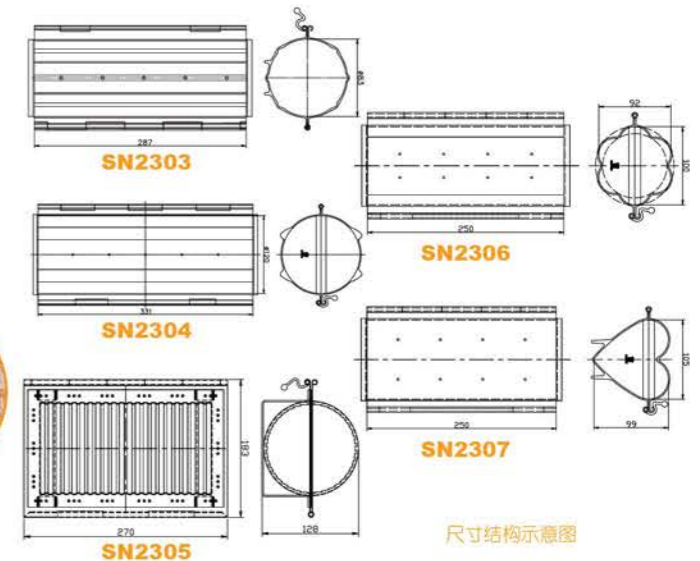



工具系列	其他工具系列	蛋糕转台系列	打蛋盆打蛋器系列	烙印模系列	新娘花系列	蛋糕培系列	挤花袋系列	ONEWAY系列	花瓣系列	面杆系列	SILKOMART系列	CHOCOLATE WORLD系列	巧克力模具系列
106	115	118	126	128	130	132	136	137	139	144	146	190	201

## 大蛋糕模

### 耐磨卫生易洗是您正确的选择

● 一般传统的铝制蛋糕模型，在使用一段时间后因不断擦洗使铝的表面造成磨损，因而氧化不卫生，直接影响人体健康。三能推出高强度铝合金蛋糕模制品，它运用铝合金表面处理科学技术(表面硬膜处理)，具有耐磨、不易变形及卫生等特性。

**硬膜处理** 表面耐磨、耐刮、耐酸碱易清洗。  
表面黑灰色，具有抗辐射及吸热之特性，可缩短烘焙时间，节省成本。  
采用高强度铝合金材料不易变形、导热快，确保产品品质稳定。

#### 表面处理说明

1. 硬化、氧化处理层
2. 铝合金
3. 硬化铝合金

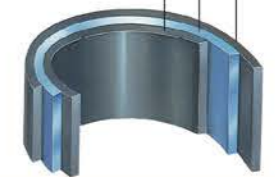

1.2mm铝合金

#### 活动凸点深蛋糕模(硬膜)

- SN5141 6" 152x145x89mm
- SN5151 8" 203x196x94mm



1.2mm铝合金

#### 活动凸点深蛋糕模(阳极)

- SN5142 6" 152x145x89mm
- SN5152 8" 203x196x94mm



1.2mm铝合金

#### 固定凸点深蛋糕模(硬膜)

- SN5143 6" 152x145x90mm
- SN5153 8" 203x196x95mm



1.2mm铝合金

#### 固定凸点深蛋糕模(阳极)

- SN5144 6" 152x145x90mm
- SN5154 8" 203x196x95mm

# 凸点深蛋糕模

有高度的蛋糕 有范 不一样的时尚

高强度铝合金制成，轻巧耐用  
凸点设计，便于堆叠、拿取  
硬膜、阳极两种表面处理供选  
活动、固定两种款式供选

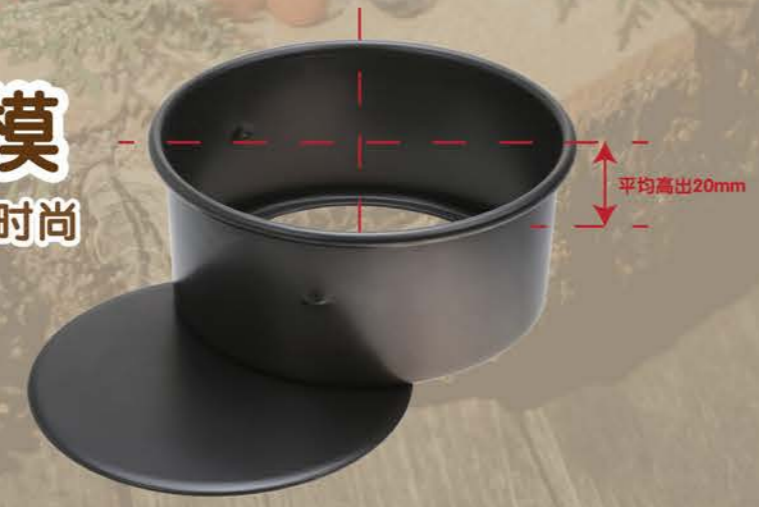

专利蛋糕模 专利号：200720042980.7

**小凸点、大功用、取放便利**  
蛋糕模易取易放的重大突破，解决使用者多年的困扰



1.0mm铝合金

活动凸点蛋糕模(硬膜)

SN5025	6"	152x147x69mm
SN5035	7"	178x172x74mm
SN5045	8"	203x197x74mm
SN5055	9"	229x223x74mm
SN5065	10"	254x248x79mm
SN5075	12"	305x299x79mm
SN5085	14"	356x350x79mm



1.0mm铝合金

固定凸点蛋糕模(硬膜)

SN5027	6"	152x147x70mm
SN5037	7"	178x172x75mm
SN5047	8"	203x197x75mm
SN5057	9"	229x223x75mm
SN5067	10"	254x248x80mm
SN5077	12"	305x299x80mm



1.0mm铝合金

活动凸点蛋糕模(阳极)

SN5026	6"	152x147x69mm
SN5036	7"	178x172x74mm
SN5046	8"	203x197x74mm
SN5056	9"	229x223x74mm
SN5066	10"	254x248x79mm
SN5076	12"	305x299x79mm
SN5086	14"	356x350x79mm
SN5094	16"	406x400x79mm
SN5104	18"	457x451x79mm



凸点造型，取放容易



1.0mm铝合金

固定凸点蛋糕模(阳极)

SN5028	6"	152x147x70mm
SN5038	7"	178x172x75mm
SN5048	8"	203x197x75mm



小凸点、大功能  
存放整齐、省时又省力

大蛋糕模



1.0mm铝合金

活动蛋糕模(硬膜)

SN5001	4"	102x98x59mm
SN5011	5"	127x123x59mm
SN5021	6"	152x147x69mm
SN5041	8"	203x197x74mm



1.0mm铝合金

固定蛋糕模

SN5003	4"	硬膜 102x98x60mm
SN5013	5"	硬膜 127x123x60mm
SN5009	4"	(1000系列不沾) 102x98x60mm



1.0mm铝合金

活动蛋糕模(阳极)

SN5022	6"	152x147x69mm
SN5042	8"	203x197x74mm



1.0mm铝合金

6"活动日式戚风蛋糕模(阳极)

SN5234	6"	152x130x115mm
--------	----	---------------



1.0mm铝合金

活动方型蛋糕模(硬膜)

SN5121	8"	145x145x60mm
SN5123	10"	180x180x60mm
SN5125	12"	215x215x60mm

001

017

020

028

036

042

050

058

064

072

080

090

106

115

118

126

128

130

132

136

137

139

144

146

190

201

### 布丁蛋糕模



1.0mm铝合金

#### 活动布丁模(硬膜)

SN5221 5" 127x113x57mm

SN5231 6" 152x135x70mm

SN5251 8" 203x183x80mm



1.0mm铝合金

#### 活动布丁模(阳极)

SN5222 5" 127x113x57mm

SN5232 6" 152x135x70mm

SN5252 8" 203x183x80mm



1.0mm铝合金

#### 圆型布丁心(阳极)

SN5293 6" 圆径130x105mm

SN5295 8" 圆径181x100mm

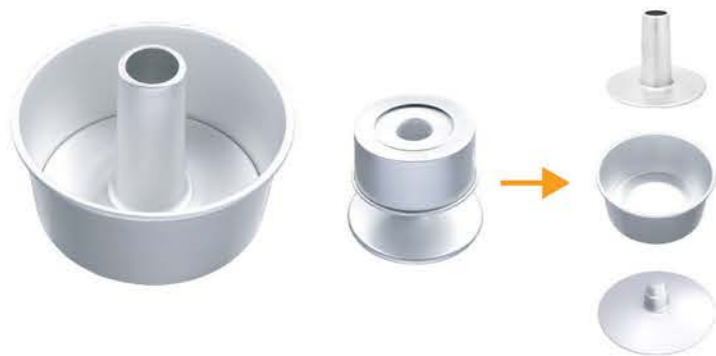

1.0mm铝合金

#### 活动圆型空心布丁模(阳极)

SN5280 100x80x54mm

SN5281 150x135x80mm

SN5282 180x170x90mm

SN5283 210x195x95mm

新品 SN5286 130x114x80mm

### 心型蛋糕模



1.0mm铝合金

#### 活动心型模(硬膜)

SN6904 6" 142x134x55mm

SN6906 8" 189x178x60mm

SN6908 10" 236x222x67mm



1.0mm铝合金

#### 活动心型模(阳极)

SN6844 6" 142x134x55mm

SN6846 8" 189x178x60mm

SN6848 10" 236x222x67mm



1.0mm铝合金

#### 固定心型模(硬膜)

SN6914 6" 142x134x55mm

SN6916 8" 189x178x60mm

SN6918 10" 236x222x67mm



1.0mm铝合金

#### 固定心型模(阳极)

SN6851 3" 73x68x27mm

SN6852 4" 93x88x35mm

SN6853 5" 118x111x40mm



工具系列	其他工具系列	蛋糕转台系列	打蛋盆打蛋器系列	烙印模系列	新娘花系列	蛋糕培系列	挤花袋系列	ONEWAY系列	花瓣系列	面杆系列	SILKOMART系列	WORLD系列	CHOCOLATE	巧克力模具系列
106	115	118	126	128	130	132	136	137	139	144	146	190		201

## 小蛋糕模

1.0mm铝合金



SN60015

SN60025

SN60035

SN60045

SN60055

小空心圆模-5入(阳极)

- SN60015 圆径60x20mm
- SN60025 圆径65x22mm
- SN60035 圆径70x24mm
- SN60045 圆径75x26mm
- SN60055 圆径80x28mm

0.6mm铝合金



SN60115

SN60125

SN60145

SN60175

小布丁杯-5入(阳极)

- SN60115 45x33x45mm
- SN60125 53x37x50mm
- SN60145 60x45x56mm
- SN60175 80x57x65mm

0.6mm铝合金



SN60215

SN60225

SN60235

SN60245

SN60255

SN60265

小蛋糕模-5入(阳极)

- SN60215 47x34x25mm
- SN60225 53x38x28mm
- SN60235 59x42x31mm
- SN60245 65x47x34mm
- SN60255 71x52x37mm
- SN60265 77x56x40mm

1.0mm铝合金

1.0mm铝合金

0.6mm铝合金



SN60315

SN60335

SN60345

大圆模-5入(阳极)

- SN60315 94x83x35mm
- SN60335 105x90x37mm
- SN60345 110x93x38mm

0.6mm铝合金



SN60415

SN60425

SN60435

SN60415 浅半圆模-5入(阳极) 圆径51x25mm

SN60425 浅半圆模-5入(阳极) 圆径61x30mm

SN60435 浅半圆模-5入(阳极) 圆径70x35mm

0.6mm铝合金



SN60465

SN60485

SN60465 半圆小花蛋糕模-5入(阳极) 圆径51x25mm

SN60485 半圆小花蛋糕模-5入(阳极) 圆径71x35mm

小蛋糕模

1.0mm铝合金



SN60505

SN60515

SN60525

SN60535

深半圆模-5入(阳极)

SN60505 圆径40x35mm  
SN60515 圆径53x42mm  
SN60525 圆径60x52mm  
SN60535 圆径66x58mm

0.6mm铝合金



SN61825

SN61835

SN61845

SN61855

椰子模-5入(阳极)

SN61825 49x26x17mm  
SN61835 60x30x19mm  
SN61845 71x40x21mm  
SN61855 81x50x23mm

0.6mm铝合金



SN60615

SN60645

SN60655

蛋挞模-5入(阳极)

SN60615 70x39x23mm  
SN60645 72x43x23mm  
SN60655 76x46x24mm

0.6mm铝合金



SN62915

SN62925

SN62935

SN62915 小花蛋糕模-5入(阳极) 68x46x39mm  
SN62925 小花蛋糕模-5入(阳极) 73x50x42mm  
SN62935 小花蛋糕模-5入(阳极) 79x53x45mm

0.6mm铝合金



SN62365

SN62365 半圆菊花模-5入(阳极) 圆径51x25mm

0.6mm铝合金



SN61065

SN61095

SN61065 深贝壳模-5入(阳极) 67x66x20mm  
SN61095 深贝壳模-5入(阳极) 78x47x16mm

0.6mm铝合金



SN61045

SN61055

SN61045 贝壳模-5入(阳极) 81x45x16mm  
SN61055 贝壳模-5入(阳极) 圆径68x20mm

小蛋糕模

0.6mm铝合金 1.0mm铝合金 1.0mm铝合金



SN62515

SN62525

SN62535

小花蛋糕模-5入(阳极)

SN62515 圆径70x41mm  
SN62525 81x52x38mm  
SN62535 圆径54x50mm

0.6mm铝合金



SN61435

长方形模-5入(阳极)

SN61435 88x45x15mm

0.6mm铝合金



SN64005

SN64015

SN64005 长方菊花蛋糕模-5入(阳极) 82x58x14mm  
SN64015 菱型菊花蛋糕模-5入(阳极) 89x60x19mm

0.6mm铝合金



SN64025

SN64035

SN64025 椭圆菊花蛋糕模-5入(阳极) 92x53x13mm  
SN64035 三角菊花蛋糕模-5入(阳极) 76x74x19mm

1.0mm铝合金



SN62215

SN62265

SN62215 小花蛋糕模-5入(阳极) 圆径73x39mm  
SN62265 小花蛋糕模-5入(阳极) 圆径94x30mm

0.6mm铝合金



SN61235

SN61725

SN61235 半圆足球模-5入(阳极) 圆径70x35mm  
SN61725 椭圆菊花模-5入(阳极) 75x57x18mm

0.6mm铝合金



SN61515

SN61525

SN61515 船型模-5入(阳极) 90x40x14mm  
SN61525 船型模-5入(阳极) 110x55x14mm

0.6mm铝合金



SN61615

SN61625

SN61615 船型菊花模-5入(阳极) 100x42x12mm  
SN61625 船型菊花模-5入(阳极) 120x55x14mm

1.0mm铝合金



SN61315

SN61415

SN61315 木瓜模-5入(阳极) 125x88x46mm  
SN61415 柠檬模-5入(阳极) 89x57x33mm

0.8mm铝合金



SN61455

SN61455 桃型模-5入(阳极) 82x72x36mm

001

017

020

028

036

042

050

058

064

072

080

090

小蛋糕模 0.6mm铝合金



● **SN64115** 小蛋糕模-鼠5入(阳极) 71x52x38mm



● **SN64125** 小蛋糕模-牛5入(阳极) 71x52x38mm



● **SN64135** 小蛋糕模-虎5入(阳极) 71x52x38mm



● **SN64145** 小蛋糕模-兔5入(阳极) 71x52x38mm



● **SN64155** 小蛋糕模-龙5入(阳极) 71x52x38mm



● **SN64165** 小蛋糕模-蛇5入(阳极) 71x52x38mm



● **SN64175** 小蛋糕模-马5入(阳极) 71x52x38mm



● **SN64185** 小蛋糕模-羊5入(阳极) 71x52x38mm



● **SN64195** 小蛋糕模-猴5入(阳极) 71x52x38mm



● **SN64205** 小蛋糕模-鸡5入(阳极) 71x52x38mm



● **SN64215** 小蛋糕模-狗5入(阳极) 71x52x38mm



● **SN64225** 小蛋糕模-猪5入(阳极) 71x52x38mm

★ **SN6483** 蛋糕模套装-12个组(阳极)  
(此套装包含以上12个小蛋糕模)



● **SN64235** 小蛋糕模-熊5入(阳极) 71x52x38mm



● **SN64245** 小蛋糕模-企鹅5入(阳极) 71x52x38mm



● **SN64255** 小蛋糕模-象5入(阳极) 71x52x38mm

★ **SN6482** 蛋糕模套装-3个组(阳极)



● **SN64265** 小蛋糕模-猫爪5入(阳极)  
71x52x40mm

106

115

118

126

128

130

132

136

137

139

144

146

190

201

小蛋糕模



**SN64055** 小花蛋糕冲孔模-5入(阳极) 71x52x37mm  
**SN61035** 方圆模-5入(阳极) 90x90x30mm  
**SN61485** 长条蛋糕模-5入(阳极) 223x65x25mm



**SN6132** 羊角模(1000系列不沾) 85x49x20mm  
**SN6133** 小鸡模(1000系列不沾) 102x89x25mm



**SN6204** 星型模(1000系列不沾) 圆径98x42mm  
**SN61275** 猫爪模-5入(1000系列不沾) 53x50x21mm



**SN6126** 小羊模(1000系列不沾) 62x60x25mm  
**SN6870** 六角蛋糕模(1000系列不沾) 146x100x46mm



**SN6129** 小鸭模(1000系列不沾) 85x68x30mm  
**SN62005** 小花蛋糕模-5入(1000系列不沾) 77x70x18mm



**SN6201** 小花蛋糕模(1000系列不沾) 100x97x24mm  
**SN62085** 梅花模-5入(1000系列不沾) 70x60x25mm



**SN6134** 爱心模(1000系列不沾) 100x60x25mm  
**SN6137** 蝴蝶模(1000系列不沾) 76x54x25mm



**SN6864** 半圆蛋糕模(1000系列不沾) 圆径150x110mm  
**SN6865** 半圆蛋糕模(1000系列不沾) 圆径100x75mm



**SN6129** **SN6127** **SN6126**

★ **SN6481** 蛋糕模套装-3个组(1000系列不沾)

小蛋糕模

1.0mm镀铝      0.5mm镀铝      0.5mm镀铝

**SN60325**      **SN62095**      **SN62105**

**SN60325** 大圆模-5入(1000系列不沾)      105x90x37mm  
**SN62095** 方型模-5入(1000系列不沾)      80x60x12mm  
**SN62105** 长方形模-5入(1000系列不沾)      95x45x15mm

0.8mm镀铝      黄铜

**SN61445**      **SN6501**      **SN6502**

**SN61445** 热狗模-5入(1000系列不沾)      180x60x16mm  
**SN6501** 卡娜雷铜模-中      44x44mm  
**SN6502** 卡娜雷铜模-大      55x50mm

1.0mm铝合金

**SN6601**      **SN6602**

**SN6601** 海绵盒(阳极)      96x66x40mm  
**SN6602** 海绵盒(阳极)      110x83x42mm

1.0mm铝合金

**SN6604**      **SN6605**

**SN6604** 海绵盒(800系列不沾)      96x66x40mm  
**SN6605** 海绵盒(800系列不沾)      110x83x42mm

1.0mm铝合金

**SN6860**      **SN6861**

**SN6860** 乳酪蛋糕模(1000系列不沾)      214x100x55mm  
**SN6861** 乳酪蛋糕模(阳极)      214x100x55mm

1.0mm铝合金

**SN6863**

**SN6863** 乳酪蛋糕模(1000系列不沾)      214x100x55mm

1.0mm铝合金      0.6mm铝合金

**SN61945**      **SN62115**

**SN61945** 小花蛋糕模-5入(阳极)      80x48x24mm  
**SN62115** 小花蛋糕模-5入(阳极)      75x41x28mm

0.6mm铝合金      0.8mm铝合金

**SN62155**      **SN6801**

**SN62155** 小花蛋糕模-5入(阳极)      圆径50x27mm  
**SN6801** 空心菊花模(阳极)      143x90x62mm

0.6mm铝合金

**SN61025**      **SN61115**

**SN61025** 星模-5入(阳极)      圆径70x22mm  
**SN61115** 尖梅花模-5入(阳极)      76x26x40mm

1.0mm铝合金

**SN63015**      **SN63035**      **SN63045**

**SN63015** 小花蛋糕模-5入(阳极)      105x81x29mm  
**SN63035** 小花蛋糕模-5入(阳极)      105x81x29mm  
**SN63045** 小花蛋糕模-5入(阳极)      105x81x29mm

小蛋糕模

1.0mm铝合金

**SN6831**      **SN6832**      **SN6833**      **SN6834**

空心圆模(阳极)

**SN6831** 圆径110x50mm  
**SN6832** 圆径130x55mm  
**SN6833** 圆径178x60mm  
**SN6834** 圆径215x70mm

铸铝

**SN6804**      **SN6809**      **SN6807**

**SN6807** 八星菊花模-小(800系列不沾)      圆径82x64mm  
**SN6809** 八星菊花模-中(800系列不沾)      圆径132x104mm  
**SN6804** 八星菊花模-大(800系列不沾)      圆径168x129mm

铸铝

**SN6806**      **SN6808**      **SN6805**

**SN6805** 八星菊花模-小(1000系列不沾)      圆径82x64mm  
**SN6808** 八星菊花模-中(1000系列不沾)      圆径132x104mm  
**SN6806** 八星菊花模-大(1000系列不沾)      圆径168x129mm

0.8mm铝合金

**SN6884**

**SN6884** 车轮模(800系列不沾)      130x80x40mm

镀铝

**SN6871**

**SN6871** 鹿背蛋糕模(1000系列不沾)      215x89x62mm

0.7mm镀铝

**SN6880**

**SN6880** 罗兰蛋糕模(800系列不沾)      227x76x50mm

1.0mm铝合金

**SN6820**      **SN6821**

**SN6820** 浅双层空心菊花模(阳极)      圆径179x64mm  
**SN6821** 浅双层空心菊花模(阳极)      圆径179x63mm

1.0mm铝合金

**SN6823**      **SN6824**

**SN6823** 双层空心菊花模(阳极)      圆径180x95mm  
**SN6824** 双层空心菊花模(阳极)      圆径220x115mm

0.9mm铝合金      0.6mm铝合金

**SN6813**      **SN68305**

**SN6813** 浅弯曲空心菊花模(阳极)      圆径190x47mm  
**SN68305** 空心圆模-5入(阳极)      圆径94x33mm



工具系列	其他工具系列	蛋糕转台系列	打蛋盆打蛋器系列	烙印模系列	新娘花系列	蛋糕塔系列	挤花袋系列	ONEMAY系列	花瓣系列	面料系列	SILKOMART系列	CHOCOLATE WORLD系列	巧克力模具系列
106	115	118	126	128	130	132	136	137	139	144	146	190	201

## 慕斯圈



0.8mm304不锈钢

### 圆型圈-5入

<b>SN32125</b>	圆径50x16mm
<b>SN32145</b>	圆径60x16mm
<b>SN32155</b>	圆径65x16mm
<b>SN32165</b>	圆径70x16mm
<b>SN32315</b>	圆径45x20mm
<b>SN32185</b>	圆径80x20mm
<b>SN32195</b>	圆径85x20mm
<b>SN32325</b>	圆径50x25mm
<b>SN32335</b>	圆径55x30mm
<b>SN32345</b>	圆径60x30mm
<b>SN32355</b>	圆径65x35mm
<b>SN32365</b>	圆径70x35mm
<b>SN32375</b>	圆径75x35mm
<b>SN32385</b>	圆径80x40mm
<b>SN32395</b>	圆径85x40mm
<b>SN32405</b>	圆径90x40mm
<b>SN32415</b>	圆径100x40mm
<b>SN34735</b>	圆径55x50mm
<b>SN34745</b>	圆径60x50mm
<b>SN34755</b>	圆径65x50mm
<b>SN34765</b>	圆径70x50mm
<b>SN34775</b>	圆径75x50mm
<b>SN34785</b>	圆径80x50mm
<b>SN34795</b>	圆径85x50mm
<b>SN34805</b>	圆径90x50mm
<b>SN34825</b>	圆径100x50mm



1.2mm304不锈钢

### 圆型圈

<b>SN3223</b>	圆径140x30mm
<b>SN3224</b>	圆径160x30mm
<b>SN3225</b>	圆径180x30mm
<b>SN3242</b>	圆径127x40mm
<b>SN3243</b>	6" 圆径152x50mm
<b>SN3244</b>	7" 圆径178x50mm
<b>SN3245</b>	8" 圆径203x50mm
<b>SN3246</b>	9" 圆径229x50mm
<b>SN3247</b>	10" 圆径254x50mm

慕斯圈

表面经硬膜处理，耐刮、易清洗。  
硬膜产品，禁止采用水蒸气清洗及煮煮，否则易造成产品氧化，表面处理层脱落。



2.0mm铝合金

圆型圈(硬膜)

SN3858	圆径120x30mm
SN3859	圆径140x30mm
SN3860	圆径160x30mm
SN3861	圆径180x30mm
SN3863	6" 圆径152x50mm
SN3865	8" 圆径203x50mm
SN3867	10" 圆径254x50mm



2.0mm铝合金

圆型圈(阳极)

SN3790	圆径203x30mm
SN3739	圆径100x40mm
SN3740	圆径100x50mm



椭圆圈

0.8mm304不锈钢

SN32525	5入 50x35x25mm
SN32565	5入 70x45x35mm
SN32605	5入 90x60x40mm
SN32555	5入 70x45x50mm

1.2mm304不锈钢

SN3263	6" 152x110x50mm
SN3265	8" 203x145x50mm
SN3267	10" 254x180x50mm

1.0mm铝合金

慕斯圈垫片(硬膜)

SN3995	圆径210x1mm
SN3996	圆径250x1mm

304不锈钢

法式塔圈

SN3166	6cm法式塔圈	圆径60x20mm
SN3168	7cm法式塔圈	圆径70x20mm
SN3170	8cm法式塔圈	圆径80x20mm
SN3172	9cm法式塔圈	圆径90x20mm
SN3173	10cm法式塔圈	圆径100x20mm
SN3174	11cm法式塔圈	圆径110x20mm
SN3175	12cm法式塔圈	圆径120x20mm



慕斯圈



心型圈

0.8mm304不锈钢

SN33545	5入 65x65x50mm
SN33555	5入 65x65x35mm
SN33575	5入 75x75x35mm
SN33595	5入 85x85x40mm
SN33625	5入 120x113x35mm

1.2mm304不锈钢

SN3363	6" 142x134x50mm
SN3364	7" 166x156x50mm
SN3365	8" 189x178x50mm
SN3366	9" 213x200x50mm
SN3367	10" 238x222x50mm

三角圈

0.8mm304不锈钢

SN32715	5入 45x41x20mm
SN32735	5入 55x49x30mm
SN32755	5入 65x58x35mm
SN32765	5入 65x58x50mm

1.2mm304不锈钢

SN3283	6" 131x114x50mm
SN3285	8" 175x153x50mm
SN3287	10" 220x192x50mm



四方圈

0.8mm304不锈钢

SN32935	5入 55x55x30mm
SN32955	5入 65x65x35mm

1.2mm304不锈钢

SN3303	6" 108x108x50mm
SN3304	7" 130x130x50mm
SN3305	8" 144x144x50mm
SN3306	9" 161x161x50mm
SN3307	10" 180x180x50mm

慕斯圈



1.2mm304不锈钢

长方圈

SN3381	125x82x30mm
SN3382	140x90x30mm
SN3383	154x102x30mm



3.0mm铝合金

长方圈(阳极)

SN3392	内径320x200x50mm
SN3380	内径570x370x60mm
SN3397	540x280x60mm
新品 SN3398	470x240x60mm



六角圈

0.8mm304不锈钢

SN33115	5入 圆径45x20mm
SN33135	5入 圆径55x30mm
SN33155	5入 圆径65x35mm
SN33165	5入 圆径65x50mm

1.2mm304不锈钢

SN3323	6" 圆径152x50mm
SN3325	8" 圆径203x50mm
SN3327	10" 圆径254x50mm



1.2mm304不锈钢

八角圈

SN3343	6" 圆径152x50mm
SN3345	8" 圆径203x50mm

慕斯圈



星型圈

0.8mm304不锈钢

SN34915	5入 圆径45x20mm
SN34935	5入 圆径55x30mm
SN34955	5入 圆径65x35mm

1.2mm304不锈钢

SN3503	6" 圆径152x50mm
SN3505	8" 圆径203x50mm
SN3507	10" 圆径254x50mm



水滴型圈

0.8mm304不锈钢

SN33945	5入 60x42x30mm
SN33965	5入 70x50x35mm

1.2mm304不锈钢

SN3403	6" 152x108x50mm
SN3405	8" 203x144x50mm
SN3407	10" 254x179x50mm



1.2mm304不锈钢

梅花型圈

SN3523	6" 圆径152x50mm
SN3525	8" 圆径203x50mm



0.8mm304不锈钢

金字塔模

SN35915	6入 60x60x43mm
SN35925	5入 72x72x51mm
SN35934	4入 84x84x60mm

金字塔模座

SN3594	6连 400x75x40mm
SN3595	5连 400x80x45mm
SN3596	4连 400x100x50mm

2017 新品上市	烤盘系列	台车系列	多连式烤盘系列	土司盒系列	大蛋糕模系列	小蛋糕模系列	慕斯圈系列	披萨盘派盘系列	GMETAL系列	刀具系列	DALBROOK系列	店前用品系列
	001	017	020	028	036	042	050	058	064	072	080	090

### 凤梨酥圈



铝合金

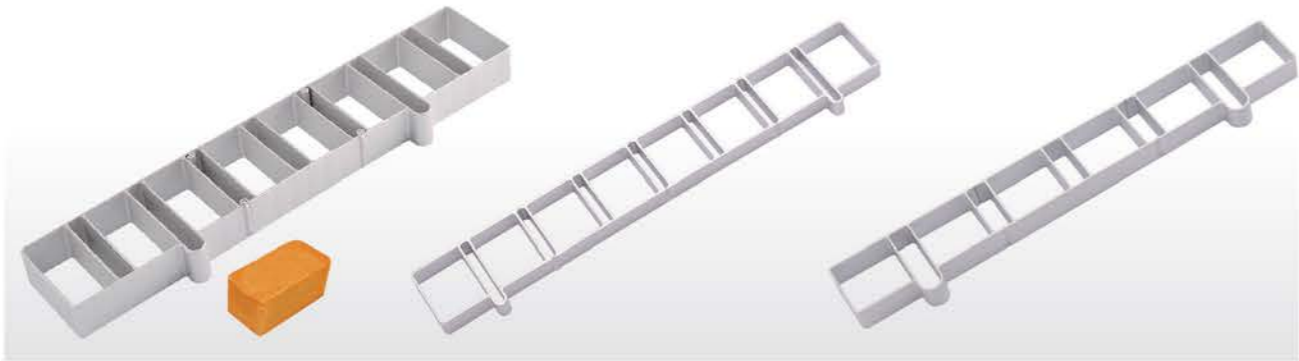

**SN9066** 8连长方型凤梨酥圈(阳极)  
363x81x28mm  
单品尺寸: 65x32mm

**SN9069** 8连长方型凤梨酥圈(阳极)  
375x64x16mm  
单品尺寸: 49x37.5mm

**SN9071** 6连正方形凤梨酥圈(阳极)  
363x63x23mm  
单品尺寸: 45x45mm

铝合金



**SN9072** 6连正方形凤梨酥圈(阳极)  
363x63x30mm  
单品尺寸: 45x45mm

**SN9073** 6连圆型凤梨酥圈(阳极)  
363x63x20mm  
单品尺寸: 圆径50mm

**SN9085** 7连椭圆型凤梨酥圈(阳极)  
362x40x18mm  
单品尺寸: 36x25mm

工具系列	其他工具系列	蛋糕转台系列	打蛋盆打蛋器系列	烙印模系列	新娘花系列	蛋糕培系列	挤花袋系列	ONEWAY系列	花瓣系列	面杆系列	SILKOMART系列	WORLD系列	CHOCOLATE	巧克力模具系列
106	115	118	126	128	130	132	136	137	139	144	146	190	201	

### 慕斯圈



# “披萨盘-圈”系列 轻松制作漂亮披萨边

媲美大师级手艺



- PC材质，掉落不易破裂
- 米白色、透明两色可选
- 耐热温度：120℃



## 3步，轻松呈现漂亮的披萨边



## 层层垒起，节省空间“披萨盘-盖”系列

### 表面硬膜处理

- 表面耐磨、耐刮、耐酸碱
- 卫生易清洗
- 表面黑灰色，具有吸热特性，可缩短烘焙时间，节省成本。

### 铝合金材质

- 质轻，强度高，不易变形
- 节能，导热速度快

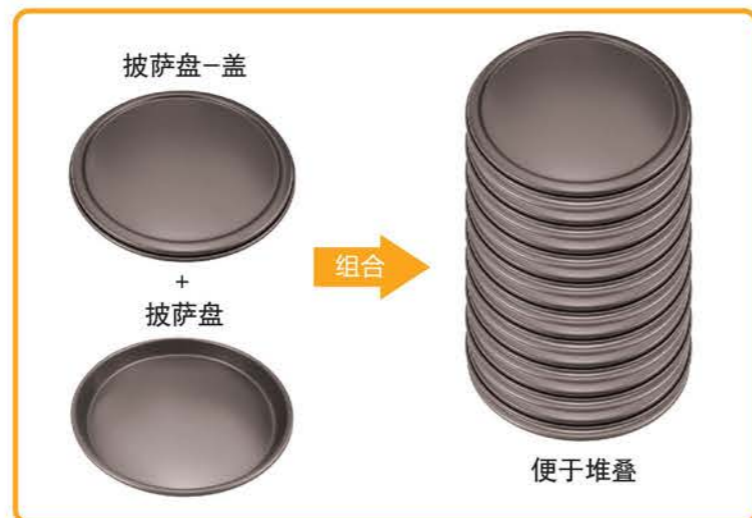

工具系列	其他工具系列	蛋糕转台系列	打蛋盆打蛋器系列	烙印模系列	新娘花系列	蛋糕培系列	挤花袋系列	ONEWAY系列	花瓣系列	面杆系列	SILKOMART系列	WORLD系列	CHOCOLATE	巧克力模具系列
106	115	118	126	128	130	132	136	137	139	144	146	190	201	

### 披萨盘-圈 & 盖

1.0mm铝合金

**披萨盘-盖(硬膜)**

SN5791	6"	圆径180x10mm
SN5800	7"	圆径206x10mm
SN5801	8"	圆径230x10mm
SN5792	9"	圆径258x10mm
SN5798	10"	圆径284x10mm
SN5793	12"	圆径333x10mm
SN5799	15"	圆径405x10mm

PC塑料

**薄饼披萨盘-盖(透明色)**

SN5802	10"	圆径263x22mm
SN5805	13"	圆径339x22mm

1.0mm铝合金

**新品 披萨盘-盖**

SN5770	6"	圆径180x10mm
SN5771	7"	圆径206x10mm
SN5772	8"	圆径230x10mm
SN5773	9"	圆径258x10mm
SN5774	10"	圆径284x10mm
SN5776	12"	圆径333x10mm
SN5777	15"	圆径405x10mm

PC塑料

**披萨盘-圈(米白色)**

SN5794	6"	圆径174x21mm
SN5795	9"	圆径252x21mm
SN5796	12"	圆径330x21mm

**薄饼披萨盘-圈(透明色)**

SN5808	10"	圆径264x23mm
SN5811	13"	圆径340x23mm

披萨盘



1.0mm铝合金

披萨盘(硬膜)

SN5741	5"	127x117x23mm
SN5742	6"	152x142x24mm
SN5743	7"	178x168x24mm
SN5744	8"	203x193x25mm
SN5745	9"	229x219x25mm



1.8mm铝合金

深披萨盘(硬膜)

SN5780	6"	152x134x36mm
SN5782	9"	231x211x36mm
SN5786	12"	305x285x36mm
SN5789	15"	377x356x38mm



1.0mm铝合金

深披萨盘(硬膜)

SN5762	6"	152x140x41mm
SN5763	7"	178x166x41mm
SN5764	8"	203x197x41mm
SN5765	9"	229x213x41mm
SN5766	10"	254x233x41mm
SN5768	12"	305x289x41mm
SN5769	13"	330x311x41mm



1.0mm铝合金

披萨网盘(阳极)

SN5532	6"	圆径152x4mm
SN5533	7"	圆径178x4mm
SN5534	8"	圆径203x4mm
SN5535	9"	圆径229x4mm
SN5536	10"	圆径254x4mm
SN5537	11"	圆径279x4mm
SN5538	12"	圆径305x4mm
SN5539	13"	圆径330x4mm
SN5540	14"	圆径356x4mm
SN5541	15"	圆径381x4mm

披萨盘

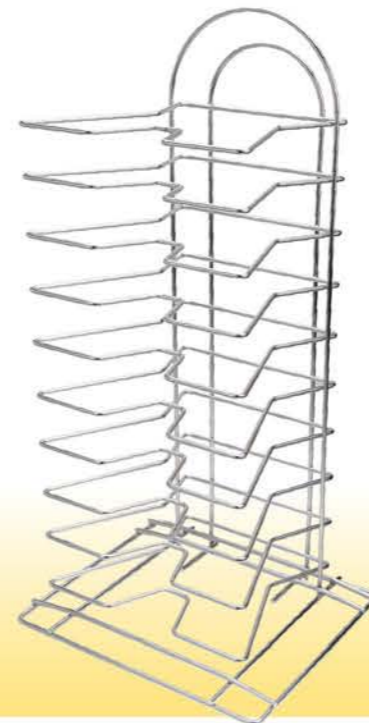

304不锈钢

披萨盘架

SN4239	306x266x630mm
--------	---------------



1.5mm铝合金

冲孔薄饼披萨盘(阳极)

SN5736	10"	254x230x15mm
SN5739	13"	330x307x15mm

薄饼披萨盘(阳极)

SN5746	10"	254x230x15mm
SN5749	13"	330x307x15mm



1.5mm铝合金

方型冲孔薄饼披萨盘(阳极)

SN5730	10"	254x254x15mm
SN5733	13"	330x330x15mm



1.5mm铝合金

方型薄饼披萨盘(阳极)

SN5750	10"	254x254x15mm
SN5753	13"	330x330x15mm

派盘



1.0mm 铝合金

派盘 (硬膜)

SN5515	7"	178x143x24mm
SN5516	8"	203x161x28mm
SN5517	9"	229x181x32mm



1.0mm 铝合金

活动心型菊花派盘 (硬膜)

SN5566	152x137x20mm
SN5567	203x185x25mm
SN5568	254x236x25mm



1.0mm 铝合金

固定菊花派盘 (硬膜)

SN5552	160x143x23mm
SN5553	200x181x25mm
SN5554	240x221x26mm



1.0mm 铝合金

活动菊花派盘 (硬膜)

SN5560	160x143x23mm
SN5561	200x181x25mm
SN5562	240x221x26mm

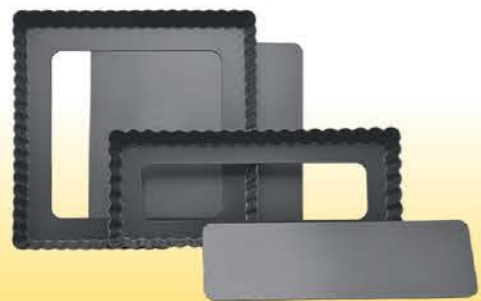

1.0mm 铝合金

活动菊花派盘 (硬膜)

SN5574	长方型	250x100x25mm
SN5577	正方形	210x210x25mm



1.0mm 铝合金

固定长方型菊花派盘 (阳极)

SN5423	120x40x25mm
--------	-------------

派盘



1.0mm 铝合金

浅盘 (硬膜)

SN5722	6"	152x127x16mm
SN5723	7"	178x152x17mm
SN5724	8"	203x178x17mm
SN5725	9"	229x203x18mm
SN5726	10"	254x229x18mm
SN5727	11"	279x254x19mm
SN5728	12"	305x279x19mm



1.0mm 铝合金

活动菊花派盘 (阳极)

SN5440	160x143x23mm
SN5441	200x181x25mm
SN5442	240x221x26mm
SN5443	280x261x26mm



1.0mm 铝合金

固定菊花派盘 (阳极)

SN5431	100x82x21mm
--------	-------------



工具系列	其他工具系列	蛋糕转台系列	打蛋盆打蛋器系列	烙印模系列	新娘花系列	蛋糕塔系列	挤花袋系列	ONEWAY系列	花瓣系列	面杆系列	SILKOMART系列	CHOCOLATE WORLD 系列	巧克力模具系列
106	115	118	126	128	130	132	136	137	139	144	146	190	201



(原SM2595499)

时间魔法套装

25.954.99.0065

圆径155x50mm  
容积约: 600ml



(原SM2598887)

火光套装

25.988.87.0065

圆径240x85mm  
容积约: 2000ml



钻石皇冠套装

25.985.87.0065

圆径240x75/206x40mm  
容积约: 2000ml



龙尾套装

25.991.87.0065

圆径240x61/213x35mm  
容积约: 2000ml



(原SM2599287)

交响乐套装

25.992.87.0065

圆径240x47mm  
容积约: 1400ml



阴阳模

20.342.87.0065

252x150x50mm  
容积约: 2500ml



001

017

020

028

036

042

050

058

064

072

080

090



海妖之歌

25.995.99.0065

300x100x36mm  
容积约: 1300ml



艾克雷亚

36.197.87.0065

295x190x35mm  
中型129x40x35mm  
容积约: 140ml



云朵模

20.341.87.0065

225x225x55mm  
容积约: 1600ml



正方体模

20.343.87.0065

175x175x50mm  
容积约: 1400ml



雪屋

36.201.87.0065

295x175x42mm  
中型圆径76x42mm  
容积约: 115ml



宝石-100ml

36.206.87.0065

295x175x30mm  
中型61x61x30mm  
容积约: 100ml



宝石-600ml

38.334.87.0065

132x132x40mm  
容积约: 600ml



宝石-1000ml

38.335.87.0065

160x160x50mm  
容积约: 1000ml



武士模

36.210.87.0065

300x175x35mm  
中型圆径70x35mm  
容积约: 110ml



方型模

36.216.87.0065

300x175x50mm  
中型60x60x50mm  
容积约: 150ml



山莓模套装

28.310.87.0065

405x92x67mm  
中型圆径65x67mm  
容积约: 110ml



俄罗斯故事

28.311.87.0065

400x95x75mm  
中型圆径67x73mm  
容积约: 125ml



106

115

118

126

128

130

132

136

137

139

144

146

190

201

001

017

020

028

036

042

050

058

064

072

080

090

106

115

118

126

128

130

132

136

137

139

144

146

190

201



链型方体模

**32.147.87.0065**

385x285x42mm  
中型375x42x42mm  
容积约: Tot 2000ml



链型三角模

**32.148.87.0065**

385x285x46mm  
中型375x46x51mm  
容积约: Tot 2000ml



小珍珠

**36.203.87.0065**

300x175x6mm  
中型圆径7x6mm  
容积约: 1ml



迷你心型模

**36.227.87.0065**

300x175x14mm  
中型23x25x13mm  
容积约: 5ml



迷你屋顶硅胶模

**36.221.87.0065**

300x175x15mm  
中型圆径26x14mm  
容积约: 5ml



迷你萨伐仑松饼模

**36.222.87.0065**

300x175x13mm  
中型圆径26x12mm  
容积约: 5ml



迷你椭圆模

**36.223.87.0065**

300x175x13mm  
中型26x19x12mm  
容积约: 5ml



迷你圆型模

**36.224.87.0065**

300x175x12mm  
中型圆径24x12mm  
容积约: 5ml



迷你方型模

**36.225.87.0065**

300x175x14mm  
中型21x21x13mm  
容积约: 5ml



迷你石块模

**36.226.87.0065**

300x175x14mm  
中型圆径26x12mm  
容积约: 5ml



迷你宝石模

**36.228.87.0065**

300x175x13mm  
中型23x23x13mm  
容积约: 5ml



001

017

020

028

038

042

050

058

064

072

080

090



(原SI3806) **25.956.99.0065**  
仙女的翅膀套装-7个组  
330x135x50mm  
容积约: 1400ml



106

115

118

126

128

130

132

136

137

139

144

146

190

201



**25.987.87.0065** 心型模组 100x100x30mm  
(原SM2598787) 容积约: 270ml



**36.200.87.0065** 15连心型模 45x44x24mm  
(原SM3620087) 容积约: 30ml/个

操作步骤:



001

017

020

028

038

042

050

058

064

072

080

090

106

115

118

126

128

130

132

136

137

139

144

146

190

201



2015年里昂甜点世界杯



意大利队夺冠  
SILKOMART PROFESSIONAL  
为意大利队研发的夺冠模具

(原SI3805) 25.955.99.0065

时间魔法套装  
圆径208x61mm  
容积约: 1000ml

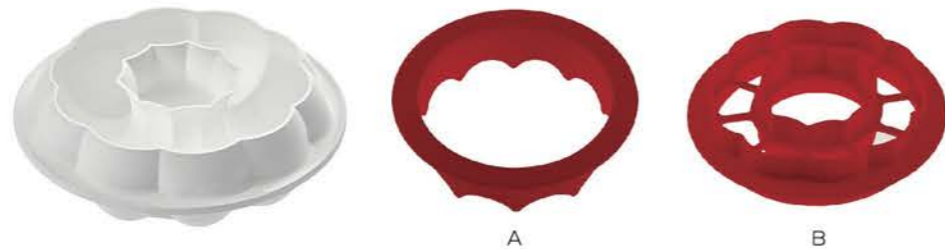

A

B



A使用方法



A使用方法

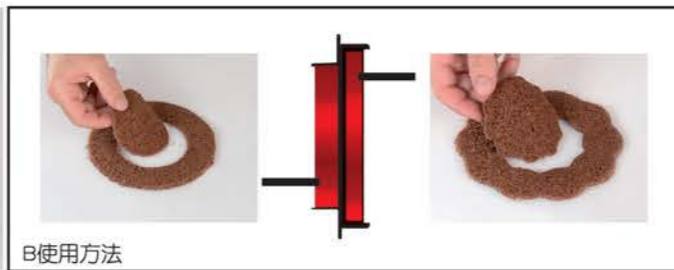

B使用方法



心型模套装 (原SI3803 SI3804)

32.860.87.0165 142x137x50mm  
容积约: 600ml  
32.890.87.0065 170x164x63mm  
容积约: 1040ml



石头模套装 (原SI3197 SI3198 SI3199)

38.331.87.0065 205x168x70mm 容积约: 1000ml  
38.333.87.0065 143x110x50mm 容积约: 300ml  
38.336.87.0065 175x135x65mm 容积约: 600ml



25.938.87.0065 (原SI3938) 弯月模套组  
270x50x50 280x60x71 圆径32x28mm 容积约: 960ml



**27.196.87.0065** 圆型模 圆径208x68mm  
(原SI3136) 容积约: 1545ml



**27.201.87.0065** 泡泡模 180x180x50mm  
(原SM2720187) 中型圆径30x35mm  
容积约: 1400ml

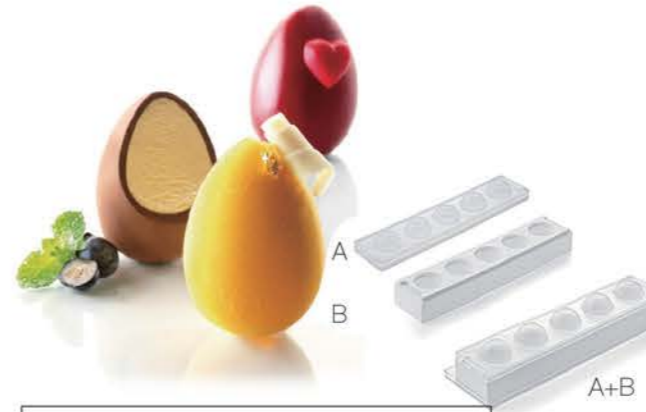

**25.307.99.0065** 5连蛋型模 395x118x65mm  
(原SI3307) 中型50x73mm  
容积约: 100ml



(原SI3301 SI3303 SI3305)

**25.301.99.0065** 5连球型模 395x118x51mm  
容积约: 102ml 中型圆径58mm  
**25.303.99.0065** 5连球型模 395x118x48mm  
容积约: 58ml 中型圆径48mm  
**25.305.99.0065** 12连球型模 395x118x34mm  
容积约: 11.5ml 中型圆径28mm



半球模 (原SI3011 SI3013 SI3016 SI3018)

**27.011.87.0098** 圆径115x57.5mm 容积约: 409ml  
**27.013.87.0098** 圆径135x67.5mm 容积约: 654ml  
**27.016.87.0098** 圆径160x80mm 容积约: 1108ml  
**27.018.87.0098** 圆径180x90mm 容积约: 1570ml



**22.865.87.0165** 提花凸纹模 160x160x53mm  
(原SI3865) 容积约: 1000ml



方型模 (原SI3410 SI3412 SI3413 SI3513 SI3516 SI3518)

**27.410.87.0098** 100x100x40mm 容积约: 396ml  
**27.412.87.0098** 120x120x40mm 容积约: 572ml  
**27.413.87.0098** 135x135x40mm 容积约: 714ml  
**27.513.87.0098** 135x135x50mm 容积约: 982ml  
**27.516.87.0098** 160x160x50mm 容积约: 1273ml  
**27.518.87.0098** 180x180x50mm 容积约: 1558ml



圆型模 (原SI3104 SI3115 SI3135 SI3613 SI3616 SI3618)

**27.104.87.0098** 圆径100x40mm 容积约: 312ml  
**27.115.87.0098** 圆径115x40mm 容积约: 413ml  
**27.135.87.0098** 圆径135x40mm 容积约: 570ml  
**27.613.87.0098** 圆径135x50mm 容积约: 705ml  
**27.616.87.0098** 圆径160x50mm 容积约: 1000ml  
**27.618.87.0098** 圆径180x50mm 容积约: 1266ml



图为与SI3180配合制作而成

**25.149.87.0098** 6连圆型模-2入  
(原CUPOLE01) 295x175x20mm  
中型圆径80x20mm  
容积约: 54ml



图为与SI3135配合制作而成

**25.150.87.0098** 6连圆型模  
(原CUPOLE02) 390x295x20mm  
中型圆径120x20mm  
容积约: 117ml



**32.146.87.0065** 4连连珠模  
(原SI3146) 375x47x40mm  
容积约: 2000ml

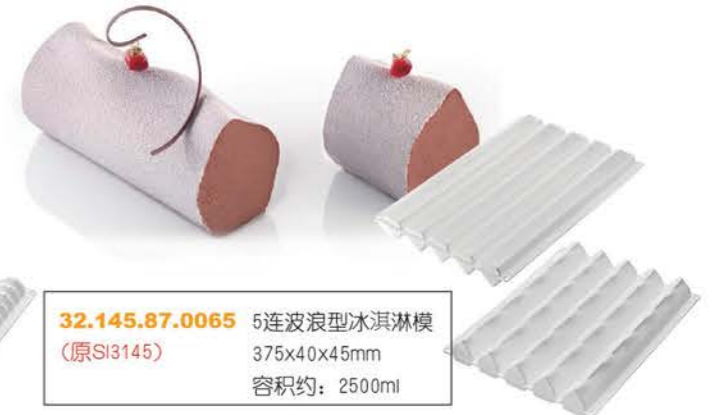

**32.145.87.0065** 5连波浪型冰淇淋模  
(原SI3145) 375x40x45mm  
容积约: 2500ml

001

017

020

028

038

042

050

058

064

072

080

090

106

115

118

126

128

130

132

136

137

139

144

146

190

201



**28.001.87.0065** 圆圈模  
(原SI3001) 255x275x25mm



**28.002.87.0065** 方圈模  
(原SI3002) 255x275x25mm



**半圆型模** (原SI3226 SI3259)

**27.226.87.0060** 220x60x50mm 容积约: 565ml  
**27.259.87.0060** 250x70x90mm 容积约: 1300ml



**枕型模** (SI3802 SI3807 SI3808)

**22.802.87.0065** 219x94x70mm 容积约: 700ml  
**32.801.87.0065** 190x73x60mm 容积约: 600ml (套装)  
**32.802.87.0065** 217x94x70mm 容积约: 1039ml (套装)



**27.225.87.0060** 山型模 225x60x69mm  
(原SI3225) 容积约: 600ml



**27.258.87.0060** 山型模 250x80x90mm  
(原SI3258) 容积约: 1200ml



**圆型模**

**28.201.87.0165** 圆径180x45mm  
(原SI3201) 容积约: 1000ml

**操作步骤:**

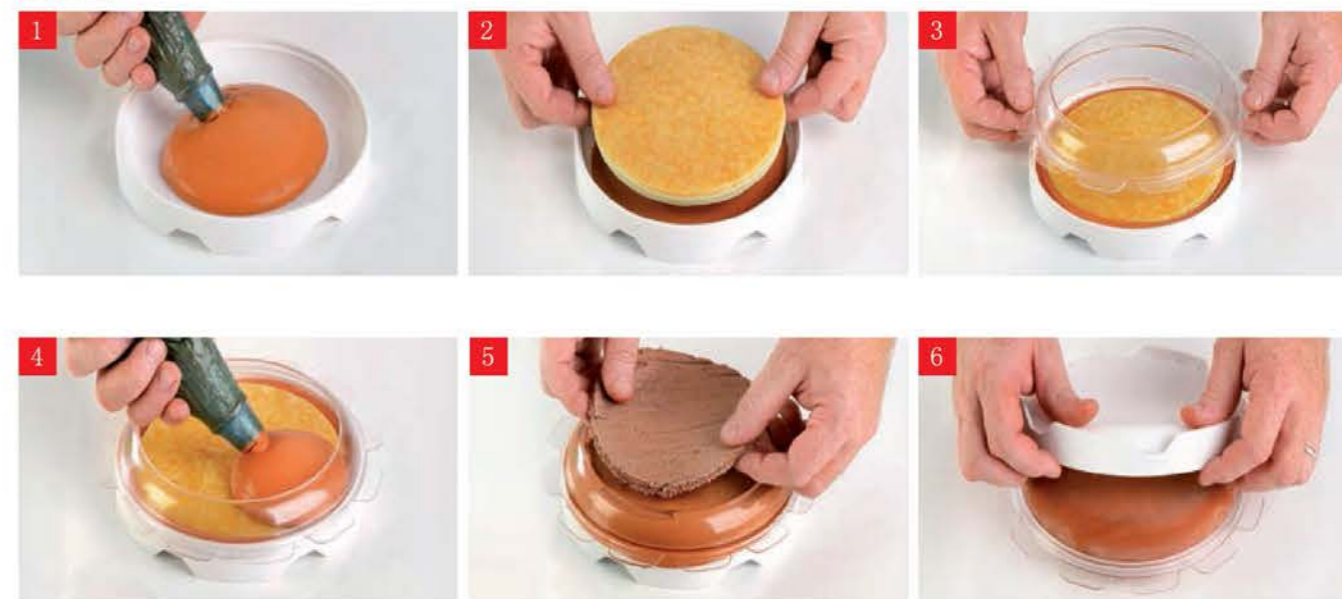

001

017

020

028

038

042

050

058

064

072

080

090

原SI2051、SI2052、SI2053、SI2054、SI2058、SI3055、SI3056、25.073.99.0065包含此模具  
非硅胶模组不包含



(原SI2051 TEX01)

**25.051.99.0065** 木纹蛋糕卷模组 290x125x72/250x185x6mm  
**33.051.20.0065** 木纹垫模 250x185x6mm  
容积约: 1300ml



(原SI2052 TEX02-1)

**25.052.99.0065** 编织纹蛋糕卷模组 294x127x73/250x185x4mm  
**33.052.20.0065** 编织垫模 250x185x4mm  
容积约: 1300ml



(原SI2053 TEX03-1)

**25.053.99.0065** 菱形蛋糕卷模组 290x125x72/250x185x5mm  
**33.053.20.0065** 菱形垫模 250x185x5mm  
容积约: 1300ml



(原SI2054 TEX04)

**25.054.99.0065** 圆点纹蛋糕卷模组 294x127x73/250x185x6mm  
**33.054.20.0065** 圆点垫模 250x185x3mm  
容积约: 1300ml

106

115

118

126

128

130

132

136

137

139

144

146

190

201

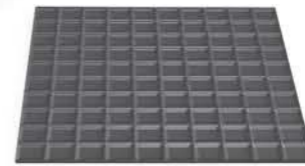

新品

**25.073.99.0065** 砖纹半圆模套装 295x127x73mm  
**33.073.20.0065** 砖块模 250x185x6mm  
容积约: 1300ml



(原SI2058 TEX08)

**25.058.99.0065** 爱心蛋糕卷模组 300x127x73/250x185x4mm  
**33.058.20.0065** 爱心垫模 250x185x4mm  
容积约: 1300ml



(原SI3055 TEX05)

**25.055.99.0065** 阿拉伯纹蛋糕卷模组 290x125x72/250x185x3mm  
**33.055.20.0065** 阿拉伯纹垫模 250x185x3mm  
容积约: 1300ml



(原SI3056 TEX06)

**25.056.99.0065** 咖啡豆蛋糕卷模组 294x127x73/250x185x6mm  
**33.056.20.0065** 咖啡豆垫模 250x185x3mm  
容积约: 1300ml



可配套SN3380长方圈使用

**33.032.20.0096** 心型垫模  
(原SI3032) 600x400x8.5mm



可配套SN3380长方圈使用

**33.031.20.0096** 咖啡垫模  
(原SI3031) 600x400x8.5mm



空心圆模 (原SI3711 SI3715 SI3818)

**27.207.87.0065** 空心圆模  
(原SI3207) 圆径200x70x45mm  
容积约: 1232ml

**27.711.87.0065** 圆径146x128x41mm 容积约: 345ml  
**27.716.87.0060** 圆径195x195x41mm 容积约: 532ml  
**27.818.87.0060** 圆径180x60x50mm 容积约: 981ml



**27.227.87.0065** 花型模  
(原SI3227) 220x70x60mm  
容积约: 1500ml

**27.848.87.0065** 旋风型冰淇淋模  
(原SI3848) 圆径180x48mm  
容积约: 960ml



**28.205.87.0065** 涟漪模  
(原SI3205) 圆径220x47mm  
容积约: 1100ml

**28.202.87.0065** 空心波浪模  
(原SI3202) 圆径180x50mm  
容积约: 1000ml



**36.176.87.0065** 16连寿司模 300x175x25mm  
(原SF176) 中型60x30x26  
容积约: 28ml



**36.175.87.0065** 15连空心方模 300x175x27mm  
(原SF175) 中型35x35x25mm  
容积约: 26.3ml



**36.162.87.0065** 15连空心圆模 295x175x30mm  
(原SF162) 中型圆径40x25mm  
容积约: 29ml



**30.017.87.0065** 16连椭圆模 295x175x20mm  
(原SF017) 中型55x33x20mm  
容积约: 30ml



(原SI3160 SI3170 SI3180)

**28.160.87.4565** 5连圆柱型模 395x118x50mm  
容积约: 125ml 中型圆径60x45mm

**28.170.87.4565** 5连圆柱模 395x118x49mm  
容积约: 170ml 中型圆径70x45mm

**28.180.87.4565** 4连圆柱型模 395x118x51mm  
容积约: 220ml 中型圆径80x45mm



**36.186.99.0165** 8连心型模 297x176x40mm  
(原SI3186) 中型63x65x39mm  
容积约: 100ml

001

017

020

028

036

042

050

058

064

072

080

090

106

115

118

126

128

130

132

136

137

139

144

146

190

201



**36.163.87.0165** 8连球型冰淇淋模  
(原SI3163)  
圆径65x30mm  
容积约: 85ml



**36.164.87.0165** 15连圆型冰淇淋模  
(原SI3164)  
圆径45x20mm  
容积约: 26ml



**36.187.87.0065** 12连柠檬模  
(原SI3187)  
63x29x28mm  
容积约: 24ml



**36.193.99.0065** 6连石头模  
(原SI3193)  
295x175x38mm  
中型87x63x36mm  
容积约: 100ml



**36.192.87.0165** 8连松露模  
(原SI3192)  
297x175x54mm  
中型圆径62x52mm  
容积约: 120ml



**36.172.87.0165** 15连松露模  
(原SI3172)  
295x175x28mm  
中型圆径32x28mm  
容积约: 20ml



**25.120.87.0098** 6连圆型模-2入  
(原SI3120)  
295x175x25mm  
中型圆径76x25mm  
容积约: 114ml



**25.134.87.0098** 8连圆型模-2入  
(原SI3134)  
295x175x22mm  
中型圆径63x22mm  
容积约: 61ml



**36.165.99.0165** 8连圆枕型冰淇淋模  
(原SI3165)  
82x43x32mm  
容积约: 80ml



**36.185.87.0065** 6连花型模  
(原SI3185)  
300x175x40mm  
中型圆径75x37mm  
容积约: 110ml



**25.110.87.0098** 7连长方形模-2入  
(原SI3110)  
295x175x24mm  
中型87x48x24mm  
容积约: 97ml



**25.140.87.0098** 8连长方形模-2入  
(原SI3140)  
295x175x21mm  
中型70x48x20mm  
容积约: 69ml



**25.335.87.0060** 8连半圆雪糕模-2入  
(原SI3335)  
390x115x25mm  
中型69x38x18mm  
容积约: 38ml

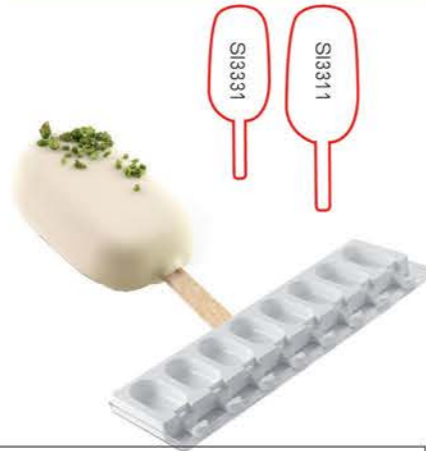

**25.331.87.0060** 8连椭圆雪糕模-2入  
(原SI3331)  
390x115x25mm  
中型69x38x18mm  
容积约: 37ml



**25.334.87.0060** 8连糖葫芦雪糕模-2入  
(原SI3334)  
390x115x25mm  
中型67x32x22mm  
容积约: 36ml



**25.318.87.0098** 4连猫型雪糕模-2入  
(原SI3318)  
395x295x30mm  
中型88x82x20mm  
容积约: 95ml



**25.316.87.0098** 4连熊爪雪糕模-2入  
(原SI3316)  
390x145x28mm  
中型89x84x24mm  
容积约: 98ml



**25.311.87.0098** 典型雪糕模-2入  
(原SI3311)  
390x145x28mm  
中型93x48x25mm  
容积约: 90ml



**25.319.87.0098** 4连3层蛋糕模-2入  
(原SI3319)  
390x145x28mm  
中型85x83x25mm  
容积约: 92ml

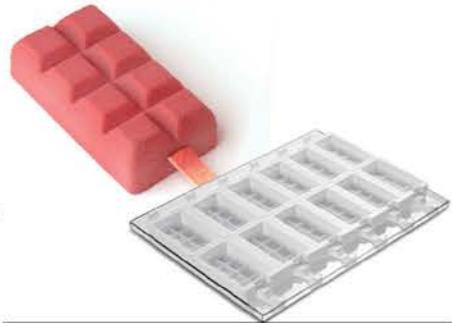

**25.312.87.0098** 6连砖型雪糕模-2入  
(原SI3322)  
390x145x28mm  
中型92x48x24mm  
容积约: 90ml



**25.317.87.0098** 4连脸型雪糕模-2入  
(原SI3317)  
390x145x28mm  
中型圆径83x22mm  
容积约: 100ml



**22.381.87.0065** 深半球模  
(原SI3381)  
385x97x23mm  
中型圆径30x22mm  
容积约: 10ml



**22.382.87.0065** 火焰模  
(原SI3382)  
385x98x36mm  
中型圆径30x35mm  
容积约: 12ml



**25.313.87.0098** 4连心型雪糕模-2入  
(原SI3313)  
390x145x28mm  
中型91x85x23mm  
容积约: 96ml



**25.333.87.0060** 6连心型雪糕模-2入  
(原SI3333)  
385x112x20mm  
中型55x68x18mm  
容积约: 45ml



**25.371.87.0065** 15连方块模-2入 195x115x25mm 中型20x20x20mm 容积约: 8ml  
**25.372.87.0065** 5连雪糕模-2入 195x115x25mm 中型60x20x20mm 容积约: 24ml  
**25.373.87.0065** 5连雪糕模-2入 195x115x25mm 中型60x20x18mm 容积约: 22ml



**透明展示盒 PC塑料**  
(原SI3425 SI3427)

**25.425.86.0000** 600x400x55mm  
**25.427.86.0000** 600x400x85mm



规格: 235x360x48mm(塑料)  
(原SI3428 SI3429 SI3430 SI3431)

**99.421.19.0165** 6槽展示盒-紫色  
**99.421.62.0165** 6槽展示盒-绿色  
**99.421.72.0165** 6槽展示盒-橙色  
**99.421.86.0165** 6槽展示盒-透明色



规格: 235x360x48mm (塑料)  
(原SI3422 SI3433 SI3434 SI3435)

**99.422.86.0165** 21连雪糕模底座-方槽  
**99.422.19.0165** 21连方槽雪糕模底座-紫色  
**99.422.62.0165** 21连方槽雪糕模底座-绿色  
**99.422.72.0165** 21连方槽雪糕模底座-橙色

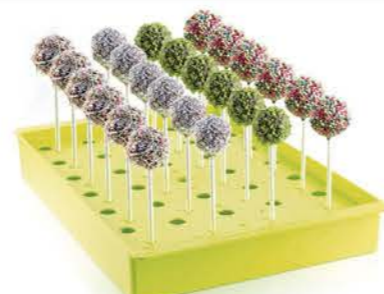
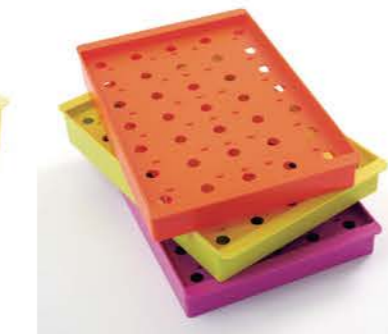

**35连/24连雪糕模底座-圆槽/方槽**  
规格: 235x360x48mm  
(原SI3432 SI3436 SI3437 SI3438)

**99.432.86.0165** 无色 (塑料)  
**99.432.19.0165** 紫色 (塑料)  
**99.432.62.0165** 绿色 (塑料)  
**99.432.72.0165** 橙色 (塑料)



**25.701.00.0060** 4连棒棒糖模-2入  
(原POP1)  
358x140x14mm  
容积约: 45ml



**25.702.00.0060** 4连姜饼人模-2入  
(原POP2)  
358x140x14mm  
容积约: 31ml



**25.703.00.0060** 4连星型模-2入  
(原POP3)  
358x140x14mm  
容积约: 34ml



**25.704.00.0060** 4连小雏菊模-2入  
(原POP4)  
358x140x14mm  
容积约: 40ml



**99.411.99.0001** 棒棒糖杆-50入  
(原SI3411)  
250x90x70mm(纸质)



规格: 圆径225.5x110mm PC塑料  
(原SI3920 SI3987)

**25.939.20.0065** 塔式展示盒-黑色  
**25.939.87.0065** 塔式展示盒-白色



热稳定性：  
覆盖大范围的烹调温度：  
-60° 到 +230° C。



实用的保养：  
可放入洗碗机中洗涤。



采用LSR液态硅胶制成



柔韧性：  
弯折后 可恢复原来的形状。



使用多元化：  
- 可放在冰箱的冷冻室及/或冷藏室  
- 可放入传统烘炉中  
- 可放入微波炉中

工具系列	其他工具系列	蛋糕转台系列	打蛋盆打蛋器系列	烙印模系列	新娘花系列	蛋糕培系列	挤花袋系列	ONEWAY系列	花瓣系列	面杆系列	SILKOMART系列	WORLD系列	CHOCOLATE系列	巧克力模具系列
106	115	118	126	128	130	132	136	137	139	144	146	190	201	



 (原SQ001)	 (原SQ002)	 (原SQ003)	 (原SQ004)
<b>70.401.20.0098</b> 24连小花模 585x387x37mm 中型圆径79x35mm 容积约: 84ml	<b>70.402.20.0098</b> 54连小花模 597x397x51mm 中型圆径56x50mm 容积约: 80ml	<b>70.403.20.0098</b> 28连半球模 590x390x36mm 中型圆径70x35mm 容积约: 90ml	<b>70.404.20.0098</b> 40连圆型模 570x375x12mm 中型圆径60x11mm 容积约: 25ml
 (原SQ005)	 (原SQ006)	 (原SQ007)	 (原SQ008)
<b>70.405.20.0098</b> 44连贝壳模 600x400x19mm 中型78x45x18mm 容积约: 30ml	<b>70.406.20.0098</b> 30连长方模 590x390x31mm 中型99x49x30mm 容积约: 130ml	<b>70.407.20.0098</b> 70连布丁模 590x390x31mm 中型圆径48x31mm 容积约: 40ml	<b>70.408.20.0098</b> 60连蛋挞模 570x375x11mm 中型圆径45x16mm 容积约: 10ml



(原SQ060)  
**70.460.20.0098**  
24连布丁模  
580x385x36mm  
中型圆径70x35mm  
容积约: 133ml



(原SQ061)  
**70.461.20.0098**  
96连小班圆球模  
565x370x18mm  
中型圆径36x17mm  
容积约: 15ml



**70.462.20.0098**  
三角模  
565x375x12mm  
中型36x38x12mm  
容积约: 9ml

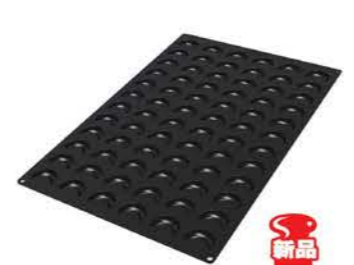

**70.463.20.0098**  
月牙模  
566x372x13mm  
中型31x47x13mm  
容积约: 9.5ml

001

017

020

028

036

042

050

058

064

072

080

090

106

115

118

126

128

130

132

136

137

139

144

146

190

201

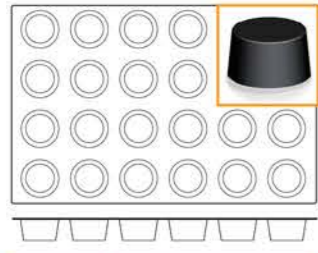

(原SQ009)

**70.409.20.0098**  
24连布丁模  
590x389x41mm  
中型圆径70x40mm  
容积约: 120ml

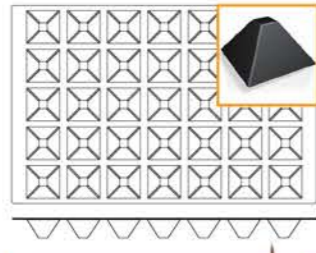

(原SQ010)

**70.410.20.0098**  
35连金字塔模  
590x389x36mm  
中型65x65x35mm  
容积约: 60ml

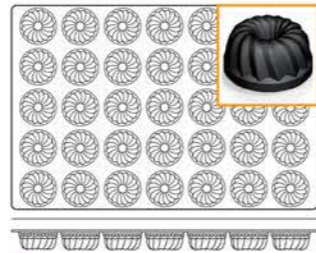

(原SQ011)

**70.411.20.0098**  
35连小花模  
600x400x36mm  
中型圆径73x36mm  
容积约: 90ml

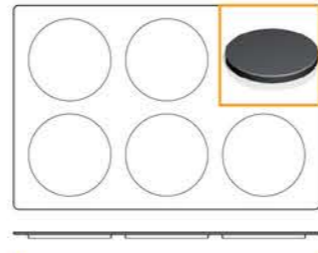

(原SQ012)

**70.412.20.0098**  
6连圆型模  
570x375x11mm  
中型圆径160x10mm  
容积约: 200ml

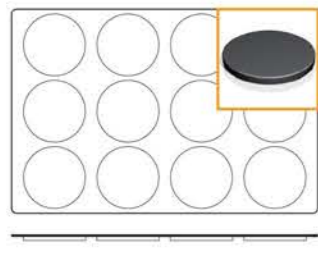

(原SQ013)

**70.413.20.0098**  
12连圆型模  
595x397x11mm  
中型圆径120x10mm  
容积约: 110ml



(原SQ014)

**70.414.20.0098**  
4连长半圆条型模  
558x390x65mm  
中型510x80x60mm  
容积约: 2200ml

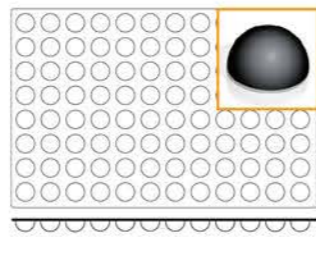

(原SQ015)

**70.415.20.0098**  
96连半球模  
569x375x19mm  
中型圆径35x17.5mm  
容积约: 11ml

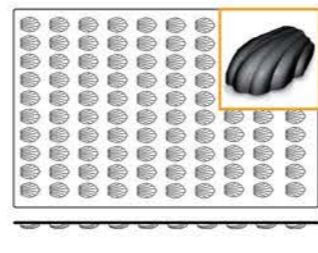

(原SQ018)

**70.418.20.0098**  
100连贝壳模  
598x398x13mm  
中型45x26x12mm  
容积约: 12ml

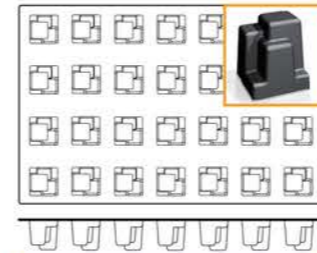

(原SQ019)

**70.419.20.0098**  
28连天边模  
590x385x60mm  
中型52x52x60mm  
容积约: 104ml

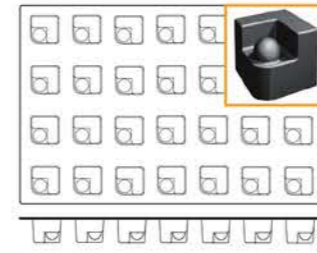

(原SQ020)

**70.420.20.0098**  
28连珍珠模  
590x390x50mm  
中型52x52x48.7mm  
容积约: 103ml



(原SQ021)

**70.421.20.0098**  
28连转角模  
590x390x50mm  
中型52x52x50.7mm  
容积约: 102ml

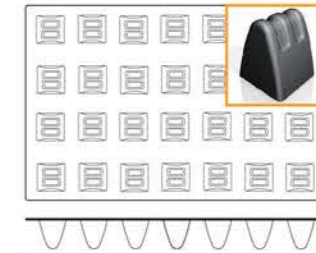

(原SQ022)

**70.422.20.0098**  
28连圆角模  
590x390x50mm  
中型52x52x61mm  
容积约: 103ml

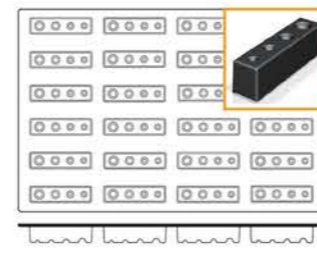

(原SQ023)

**70.423.20.0098**  
24连圆点模  
590x390x35mm  
中型117x29.4x33mm  
容积约: 107ml

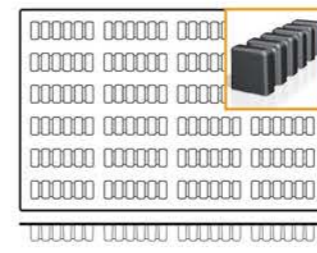

(原SQ024)

**70.424.20.0098**  
24连车轮模  
590x390x34mm  
中型117x31.8x32.7mm  
容积约: 99ml

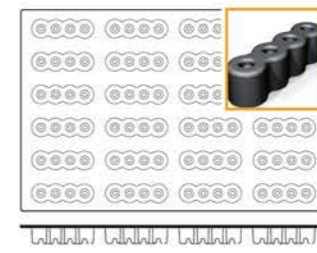

(原SQ025)

**70.425.20.0098**  
24连链型模  
590x390x35mm  
中型117x33.4x33mm  
容积约: 103ml

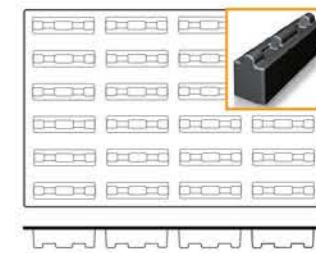

(原SQ026)

**70.426.20.0098**  
24连长条模  
590x390x40mm  
中型117.4x29.4x38.7mm  
容积约: 103ml

001

017

020

028

036

042

050

058

064

072

080

090

106

115

118

126

128

130

132

136

137

139

144

146

190

201



(原SQ027)

**70.427.20.0098**  
24连立方模  
590x390x35mm  
中型118x30x31.7mm  
容积约: 103ml



(原SQ028)

**70.428.20.0098**  
24连浪花模  
590x390x37mm  
中型120x20.5x36mm  
容积约: 100ml

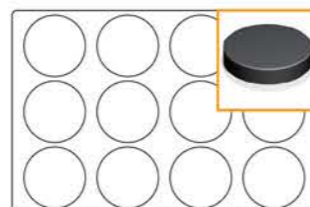

(原SQ029)

**70.429.20.0098**  
12连圆型模  
590x387x25mm  
中型圆径120x22mm  
容积约: 120ml

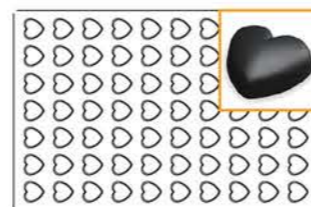

(原SQ032)

**70.432.20.0098**  
70连心型模  
567x375x17mm  
中型36x39x16mm  
容积约: 11ml

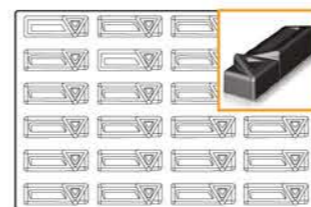

(原SQ037)

**70.437.20.0098**  
24连三角模  
585x387x32mm  
中型120x36.5x31mm  
容积约: 109.5ml

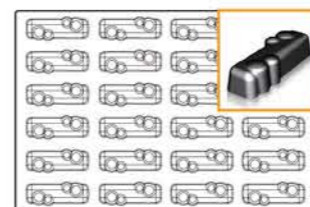

(原SQ038)

**70.438.20.0098**  
24连泡泡模  
585x387x32mm  
中型120x35x30mm  
容积约: 106ml

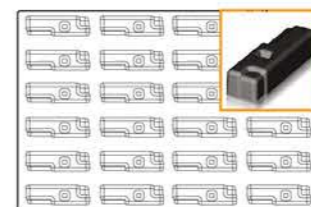

(原SQ039)

**70.439.20.0098**  
24连俄罗斯方块模  
585x387x30mm  
中型120x36x28mm  
容积约: 106ml

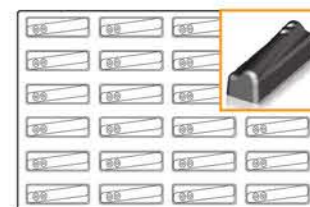

(原SQ040)

**70.440.20.0098**  
24连长条模  
585x385x35mm  
中型119x35x32mm  
容积约: 104ml

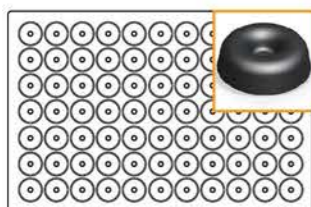

(原SQ033)

**70.433.20.0098**  
77连空心圆模  
567x375x12mm  
中型圆径41x12mm  
容积约: 12ml

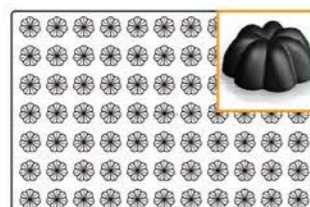

(原SQ034)

**70.434.20.0098**  
77连小花模  
567x375x15mm  
中型圆径35x15mm  
容积约: 8.5ml

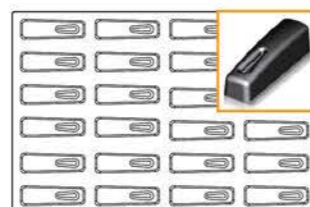

(原SQ035)

**70.435.20.0098**  
24连长条模  
585x387x35mm  
中型120x35x34mm  
容积约: 104ml

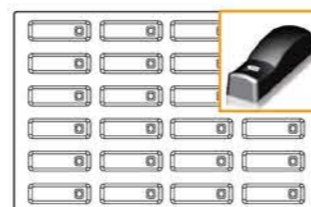

(原SQ036)

**70.436.20.0098**  
24连长条模  
585x387x34mm  
中型120x36x33mm  
容积约: 106ml

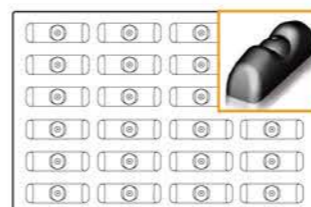

(原SQ041)

**70.441.20.0098**  
24连日落模  
588x390x36mm  
中型120x33x36mm  
容积约: 103.5ml

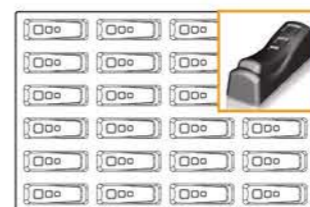

(原SQ042)

**70.442.20.0098**  
24连长条模  
588x387x35mm  
中型119x36x34mm  
容积约: 103ml

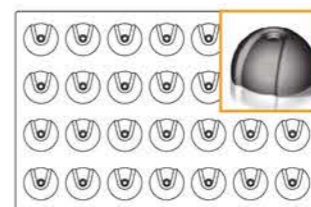

(原SQ043)

**70.443.20.0098**  
28连日落模  
588x387x40mm  
中型圆径70x37mm  
容积约: 100ml

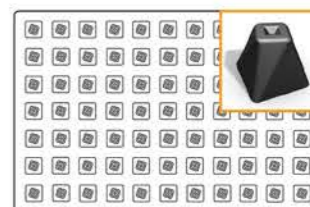

(原SQ044)

**70.446.20.0098**  
77连迷你金字塔模  
567x373x27mm  
中型28x28x25mm  
容积约: 11ml

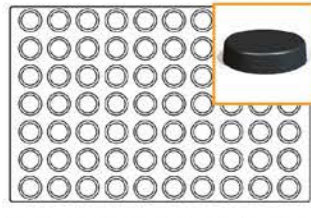

(原SQ050)

**70.450.20.0098**  
70连圆型模  
565x370x11mm  
中型圆径45x10mm  
容积约: 15ml

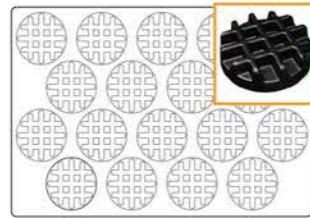

(原SQ051)

**70.451.20.0098**  
18连华夫饼模  
565x375x25mm  
中型圆径90x24mm  
容积约: 107ml

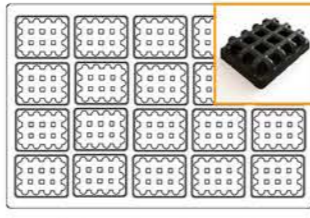

(原SQ052)

**70.452.20.0098**  
20连华夫饼模  
565x370x25mm  
中型圆径95x70x24mm  
容积约: 113ml

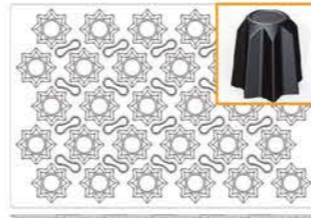

(原SQ053)

**70.453.20.0098**  
30连8星菊花模  
595x395x75mm  
中型圆径76.5x74mm  
容积约: 188ml

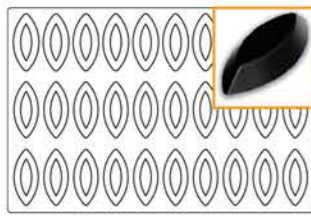

(原SQ054)

**70.454.20.0098**  
30连船型模  
568x370x15mm  
中型105x45x15mm  
容积约: 34ml

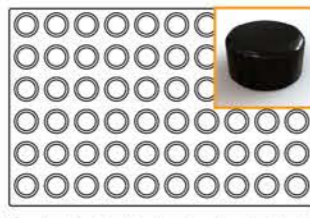

(原SQ055)

**70.455.20.0098**  
60连圆型模  
600x400x20mm  
中型圆径40x20mm  
容积约: 25ml

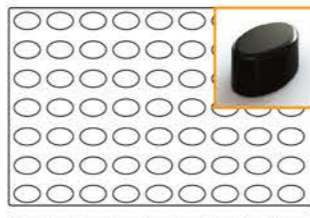

(原SQ056)

**70.456.20.0098**  
63连椭圆模  
568x370x22mm  
中型51x31x20mm  
容积约: 20ml

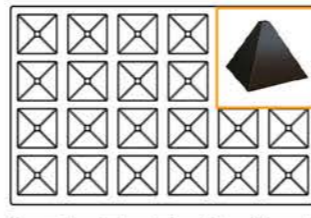

(原SQ057)

**70.457.20.0098**  
24连金字塔模  
595x390x80mm  
中型72x72x60mm  
容积约: 118ml



**30.001.00.0060 (原SF001)**  
5连半球模  
295x175x40mm  
中型圆径80x40mm  
容积约: 120ml



**30.002.00.0060 (原SF002)**  
6连半球模  
295x175x35mm  
中型圆径70x35mm  
容积约: 80ml



**30.003.00.0060 (原SF003)**  
6连小半球模  
295x175x30mm  
中型圆径60x30mm  
容积约: 60ml



**30.004.00.0060 (原SF004)**  
8连半球模  
295x175x25mm  
中型圆径50x25mm  
容积约: 30ml



**30.005.00.0060 (原SF005)**  
15连半球模  
295x175x20mm  
中型圆径40x20mm  
容积约: 20ml



**30.006.00.0060 (原SF006)**  
24连小半球模  
295x175x15mm  
中型圆径30x15mm  
容积约: 10ml



**30.007.00.0060 (原SF007)**  
6连金字塔模  
295x175x40mm  
中型71x71x40mm  
容积约: 90ml



**30.008.00.0060 (原SF008)**  
15连金字塔模  
295x175x22mm  
中型36x36x22mm  
容积约: 20ml



**30.009.00.0060 (原SF009)**  
24连小半球模  
295x175x16mm  
中型圆径34x16mm  
容积约: 18ml



**30.010.00.0060 (原SF010)**  
18连空心圆模  
295x175x12mm  
中型圆径41x12mm  
容积约: 18ml



**30.011.00.0060 (原SF011)**  
8连空心圆模  
295x175x21mm  
中型圆径65x21mm  
容积约: 50ml



**30.012.00.0060 (原SF012)**  
6连空心圆模  
295x175x23mm  
中型圆径72x23mm  
容积约: 62ml



**30.016.00.0060 (原SF016)**  
6连蛋挞模  
295x175x20mm  
中型圆径70x20mm  
容积约: 70ml

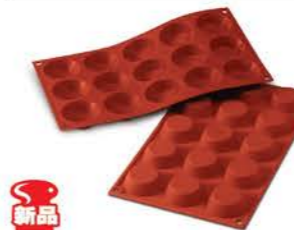

**30.014.00.0060**  
15连布丁模  
295x175x15mm  
中型圆径50x15mm  
容积约: 25ml



**30.021.00.0060 (原SF021)**  
8连布丁模  
295x175x60mm  
中型圆径55x60mm  
容积约: 92ml



**30.022.00.0060 (原SF022)**  
11连布丁模  
295x175x28mm  
中型圆径51x28mm  
容积约: 50ml

新品



**30.023.00.0060 (原SF023)**  
6连布丁模  
295x175x35mm  
中型圆径69x35mm  
容积约: 100ml



**30.025.00.0060 (原SF025)**  
20连长方模  
295x175x11mm  
中型49x26x11mm  
容积约: 20ml



**30.026.00.0060 (原SF026)**  
12连长方模  
295x175x30mm  
中型79x29x30mm  
容积约: 70ml



**30.027.00.0060 (原SF027)**  
15连布丁模  
295x175x20mm  
中型圆径40x20mm  
容积约: 30ml



**30.028.00.0060 (原SF028)**  
8连布丁模  
295x175x35mm  
中型圆径60x35mm  
容积约: 90ml



**30.030.00.0060 (原SF030)**  
24连浅半圆模  
295x175x5mm  
中型圆径35x5mm  
容积约: 5ml



**30.031.00.0060 (原SF031)**  
16连贝壳模  
295x175x10mm  
中型44x34x10mm  
容积约: 10ml



**30.032.00.0060 (原SF032)**  
9连贝壳模  
295x175x17mm  
中型68x45x17mm  
容积约: 30ml



**30.033.00.0060 (原SF033)**  
18连小花模  
295x175x35mm  
中型圆径35x35mm  
容积约: 30ml



**30.034.00.0060 (原SF034)**  
6连小花模  
295x175x37mm  
中型圆径79x37mm  
容积约: 110ml



**30.035.00.0060 (原SF035)**  
6连小花模  
295x175x30mm  
中型圆径79x30mm  
容积约: 110ml



**30.036.00.0060 (原SF036)**  
6连心型模  
295x175x40mm  
中型圆径65x40mm  
容积约: 130ml

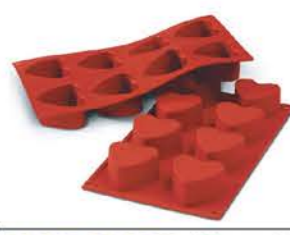

**30.040.00.0060 (原SF040)**  
8连心型模  
295x175x35mm  
中型圆径60x35mm  
容积约: 90ml



**30.041.00.0060**  
鸡蛋硅胶模  
295x175x36mm  
中型102x73x36mm  
容积约: 130ml



**30.043.00.0060 (原SF043)**  
15连布丁模  
295x175x13mm  
中型圆径40x13mm  
容积约: 20ml



**30.048.00.0060 (原SF048)**  
18连小钻石模  
295x175x23mm  
中型圆径35x23mm  
容积约: 20ml



**30.049.00.0060 (原SF049)**  
6连钻石模  
295x175x45mm  
中型圆径68x45mm  
容积约: 92ml



**30.050.00.0060 (原SF050)**  
8连小花模  
295x175x50mm  
中型圆径55x50mm  
容积约: 92ml



**30.051.00.0060 (原SF051)**  
8连小花模  
295x175x57mm  
中型圆径57x57mm  
容积约: 130ml



**30.052.00.0060 (原SF052)**  
6连布丁模  
295x175x60mm  
中型圆径75x60mm  
容积约: 165ml



**30.056.00.0060 (原SF056)**  
6连雏菊模  
295x175x28mm  
中型圆径70x28mm  
容积约: 80ml



**30.058.00.0060 (原SF058)**  
6连小花模  
295x175x36mm  
中型圆径70x36mm  
容积约: 80ml



**30.059.00.0060 (原SF059)**  
15连小花模  
295x175x45mm  
中型圆径45x45mm  
容积约: 60ml



**30.060.00.0060 (原SF060)**  
20连长方模  
295x175x20mm  
中型50x25x20mm  
容积约: 22ml



**30.061.00.0060 (原SF061)**  
6连3种小花模  
295x175x38mm  
中型圆径75x40mm  
容积约: 100ml



**30.062.00.0060 (原SF062)**  
15连小米奇模  
295x175x17mm  
中型50x50x17mm  
容积约: 20ml



**30.072.00.0060 (原SF072)**  
15连向日葵模  
295x175x25mm  
中型圆径44x27mm  
容积约: 23ml



**30.074.00.0060 (原SF074)**  
15连小玫瑰花模  
295x175x27mm  
中型圆径44x27mm  
容积约: 23ml



**30.077.00.0060 (原SF077)**  
6连大玫瑰花模  
295x175x40mm  
中型圆径76x40mm  
容积约: 115ml



**30.078.00.0060 (原SF078)**  
6连大牡丹花模  
295x175x40mm  
中型圆径78x40mm  
容积约: 115ml



**30.080.00.0060 (原SF080)**  
24连空心方模  
295x175x22mm  
中型32.5x32.5x20mm  
容积约: 16ml



**30.081.00.0060 (原SF081)**  
15连空心方模  
295x175x30mm  
中型45.5x45.5x28mm  
容积约: 45ml

001

017

020

028

036

042

050

058

064

072

080

090



**30.082.00.0060 (原SF082)**  
8连空心方模  
300x175x26mm  
中型62.5x62.5x25mm  
容积约: 73ml



**30.083.00.0060 (原SF083)**  
24连空心椭圆模  
300x175x21mm  
中型41x29x20mm  
容积约: 16ml



**30.084.00.0060 (原SF084)**  
10连空心椭圆模  
295x175x24mm  
中型67x49x23mm  
容积约: 48ml



**30.085.00.0060 (原SF085)**  
8连空心椭圆模  
300x175x28mm  
中型74x57x27mm  
容积约: 72ml



**30.086.00.0060 (原SF086)**  
6连半球模  
298x190x40mm  
中型直径75x40mm  
容积约: 115ml



**30.087.00.0060 (原SF087)**  
8连空心心型模  
300x175x32mm  
中型59x62x32mm  
容积约: 72ml



**30.088.00.0060 (原SF088)**  
10连空心心型模  
300x175x28mm  
中型49x54x28mm  
容积约: 45ml



**30.089.00.0060 (原SF089)**  
24连空心心型模  
300x175x23mm  
中型33x35x22mm  
容积约: 16ml



**30.090.00.0060 (原SF090)**  
8连空心长方模  
300x175x28mm  
中型72x45x26mm  
容积约: 72ml



**30.091.00.0060 (原SF091)**  
10连空心长方模  
300x175x26mm  
中型58x37x25mm  
容积约: 45ml



**30.092.00.0060 (原SF092)**  
25连空心长方模  
295x175x22mm  
中型41x23x21mm  
容积约: 16ml



**30.093.00.0060 (原SF093)**  
8连布丁卷模  
295x175x52mm  
中型直径60x51mm  
容积约: 72ml



**36.100.00.0060 (原SF100)**  
6连八角模  
295x175x62mm  
中型75x75x60mm  
容积约: 150ml



**36.106.00.0060 (原SF106)**  
6连姜饼人模  
300x175x22mm  
中型94.5x78x21mm  
容积约: Tot362ml



**36.107.00.0060 (原SF107)**  
8连星型模  
300x175x28mm  
中型70x25mm  
容积约: 52.5ml

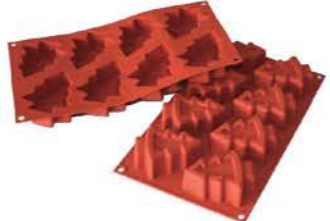

**36.108.00.0060 (原SF108)**  
8连圣诞树模  
300x175x32mm  
中型83.5x68x30.5mm  
容积约: 81ml

106

115

118

126

128

130

132

136

137

139

144

146

190

201



**36.109.00.0060 (原SF109)**  
12连小花模  
300x175x23mm  
中型直径58x22mm  
容积约: 33ml



**36.113.00.0060 (原SF113)**  
8连三层半圆模  
295x175x43mm  
中型直径55x42.5mm  
容积约: 70ml



**36.114.00.0060 (原SF114)**  
7连长条模  
295x175x25mm  
中型95x35x25mm  
容积约: 68ml



**36.115.00.0060 (原SF115)**  
11连雪花模  
295x175x35mm  
中型直径56x35mm  
容积约: 60ml



**36.116.00.0060 (原SF116)**  
8连万圣节模  
295x175x32mm  
中型70x64x32mm  
容积约: Tot572ml



**36.117.00.0060 (原SF117)**  
8连花/昆虫/蝴蝶模  
300x175x35mm  
中型77.5x77.5x32mm  
容积约: Tot646ml



**36.118.00.0060 (原SF118)**  
8连郁金香模  
300x175x30mm  
中型76.5x50.5x29.5mm  
容积约: 62.5ml



**36.119.00.0060 (原SF119)**  
8连布丁模  
295x175x40mm  
中型直径63x40mm  
容积约: 123ml



**36.125.00.0065 (原SF125)**  
24连小山模  
300x175x24mm  
中型50x18x23.5mm  
容积约: 14ml

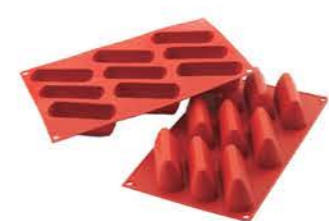

**36.126.00.0065 (原SF126)**  
9连小山模  
300x175x43mm  
中型93.5x31.5x42.5mm  
容积约: 85ml



**36.129.00.0065 (原SF129)**  
30连圆柱模  
300x175x20mm  
中型44x18x20mm  
容积约: 14ml



**36.130.00.0165 (原SF130)**  
9连长条模  
300x175x35mm  
中型84x32x35mm  
容积约: 83ml



**36.132.00.0060 (原SF132)**  
18连3种花型模  
300x175x25mm  
中型直径40x22mm  
容积约: 17.5ml



**36.135.00.0060 (原SF135)**  
15连花/昆虫/蝴蝶模  
300x175x21mm  
中型直径50x38x20mm  
容积约: Tot305ml



**36.136.00.0060 (原SF136)**  
15连圣诞树模  
300x175x25mm  
中型39x49x25mm  
容积约: Tot337.5ml



**36.137.00.0060 (原SF137)**  
6连奇异圣诞节模  
300x175x38mm  
中型73x78.5x37mm  
容积约: 115ml

001

017

020

028

036

042

050

058

064

072

080

090



**36.141.00.0060 (原SF141)**  
24连小熊模  
300x175x19mm  
中型圆径36x18mm  
容积约: 8.5ml



**36.143.00.0065 (原SF143)**  
18连迷你松饼模  
300x175x12mm  
中型圆径40x12mm  
容积约: 11.5ml



**36.145.00.0060 (原SF145)**  
8连蝉型模  
300x175x23mm  
中型72x41.5x22mm  
容积约: 35ml



**36.146.00.0060 (原SF146)**  
16连圣诞模  
300x175x7mm  
中型59x29x6.8mm  
容积约: Tot129ml

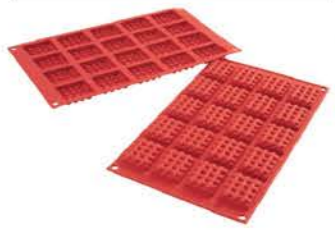

**36.147.00.0065 (原SF147)**  
20连迷你华夫饼模  
300x175x11mm  
中型45x35x10mm  
容积约: 20ml



**36.148.00.0060 (原SF148)**  
6连迷你奇妙蛋糕模  
300x175x60mm  
中型圆径75x60mm  
容积约: 177ml

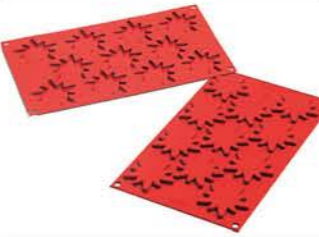

**36.151.00.0060 (原SF151)**  
11连星型模  
300x175x5mm  
中型圆径63x5mm  
容积约: 8.3ml



**36.154.00.0060 (原SF154)**  
8连小花模  
300x175x45mm  
中型圆径70x41mm  
容积约: 102ml



**36.155.00.0065 (原SF155)**  
4连华夫饼模  
300x175x18mm  
中型130x80x17mm  
容积约: 137ml



**36.157.00.0060 (原SF157)**  
8连花型模  
300x175x30mm  
中型84x66x29mm  
容积约: Tot619ml



**36.158.00.0060 (原SF158)**  
6连炫目模  
300x175x40mm  
中型圆径77x37mm  
容积约: 110ml



**36.159.00.0060 (原SF159)**  
8连圆顶模  
300x175x50mm  
中型圆径64x42mm  
容积约: 105ml



**36.166.00.0060 (原SF166)**  
15连圣诞节模  
300x175x20mm  
中型50x34x21mm  
容积约: Tot334ml



**36.168.00.0060 (原SF168)**  
6连3层小蛋糕模  
300x178x60mm  
中型69x69x60mm  
容积约: 170ml

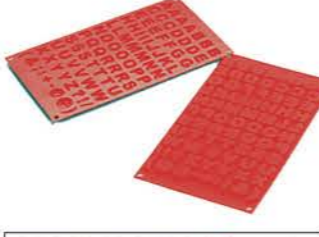

**36.169.00.0060 (原SF169)**  
77连ABC巧克力模  
300x175x10mm  
容积约: Tot115ml



**36.170.00.0065 (原SF170)**  
6连空心圆模  
300x175x30mm  
中型圆径75x28mm  
容积约: 98ml

106

115

118

126

128

130

132

136

137

139

144

146

190

201



**36.171.00.0065 (原SF171)**  
16连空心圆模  
295x170x28mm  
中型圆径45x18mm  
容积约: 22ml



**36.174.00.0060 (原SF174)**  
60连数字模  
300x175x12mm  
容积约: Tot124ml



**36.177.00.0060 (原SF177)**  
15连方型模  
300x175x15mm  
中型38x38x13mm  
容积约: 14ml



**36.178.00.0060 (原SF178)**  
15连圆型模  
300x175x15mm  
中型圆径40x13mm  
容积约: 12ml



**36.179.00.0060 (原SF179)**  
20连椭圆模  
300x175x25mm  
中型60x24.5x23mm  
容积约: 26ml



**36.184.00.0065 (原SF184)**  
8连长条模  
265x26x16mm  
容积约: 40ml

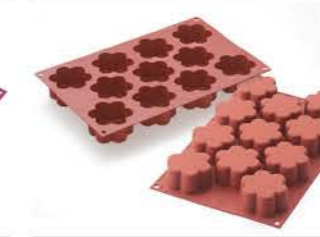

**36.194.00.0060 (原SF194)**  
11连小花模  
295x185x33mm  
中型圆径63x31mm  
容积约: 80ml



**36.195.00.0060 (原SF195)**  
16连动物组合模  
300x175x10mm  
中型60x30x8mm  
容积约: Tot168ml



**36.196.00.0060 (原SF196)**  
16连爱心组合模  
300x175x10mm  
中型60x39x8mm  
容积约: Tot142ml



**36.198.00.0060 (原SF198)**  
16连小动物组合模  
300x175x10mm  
中型60x37x8mm  
容积约: Tot160ml



**36.202.00.0060 (原SF202)**  
6连圣诞树模  
295x170x35mm  
中型88x72x33.5mm  
容积约: 100ml



**36.204.00.0060 (原SF204)**  
11连布丁模 295x170x28mm  
中型圆径50x27mm 容积约: 55ml



**36.205.00.0060 (原SF205)**  
6连布丁模 295x175x28mm  
中型圆径70x27mm 容积约: 103.5ml



**36.209.00.0060 (原SF209)**  
小花模 300x175x40mm  
中型圆径75x40mm 容积约: 100ml



**SN4249 硅胶模收纳架**  
300x255x400mm

001

017

020

028

036

042

050

058

064

072

080

090

106

115

118

126

128

130

132

136

137

139

144

146

190

201



(原HSH01)

25.601.00.0060

姜饼屋巧克力模-2个组  
305x305x14mm  
容积约: 1188ml



(原HSF01)

36.001.00.0060

4连圣诞节模  
175x150x35mm  
容积约: 272ml



(原HSF02)

36.002.00.0060

4连心型花型模  
175x150x30mm  
容积约: 280ml



(原HSF03)

36.003.00.0060

4连心型小熊模  
175x150x30mm  
容积约: 271ml



(原SFT220)

30.220.00.0060

菊花模  
圆径220x45mm  
容积约: 1300ml



(原SFT250)

30.250.00.0060

空心菊花模  
圆径220x110mm  
容积约: 2200ml



(原SFT251)

30.251.00.0060

玫瑰花模  
圆径220x100mm  
容积约: 2250ml



(原SFT315)

34.315.00.0060

空心玫瑰花模  
圆径180x75mm  
容积约: 1300ml



(原HSF04)

36.004.00.0060

4连洋娃娃模  
175x150x30mm  
容积约: 206ml



(原HSF05)

36.005.00.0060

4连赛车模  
175x150x30mm  
容积约: 372ml



(原HSF06)

36.006.00.0060

4连玩具模  
170x150x30mm  
容积约: 425ml



(原HSF07)

36.007.00.0060

4连船锚模  
170x150x30mm  
容积约: 414ml



(原SFT322)

30.322.00.0060

春天模  
圆径195x90mm  
容积约: 1800ml



(原SFT323)

30.323.00.0060

郁金香模  
圆径257x70mm  
容积约: 2800ml



(原SFT333)

30.333.00.0060

圣诞节模  
235x235x80mm  
容积约: 2700ml



(原SFT334)

30.334.00.0060

圣诞老人模  
285x270x57mm  
容积约: 2300ml



(原HSH08)

36.008.00.0060

4连欢乐海洋模  
175x150x30mm  
容积约: 248ml



(原HSH02-A)

32.603.00.0060

9连圣诞节饼干模A  
305x305x15mm  
容积约: 429ml



(原HSH02-B)

32.604.00.0060

9连圣诞节饼干模B  
305x305x15mm  
容积约: 567ml



(原HSH03-A)

32.605.00.0060

9连复活节饼干模  
305x305x15mm  
容积约: 450ml



(原SFT803)

30.803.00.0060

小泰迪熊模  
125x162x36mm  
容积约: 300ml



(原SFT805)

30.805.00.0060

空心菊花模  
圆径124x60mm  
容积约: 300ml



(原SFT812)

30.812.00.0060

泰迪熊模  
133x158x30mm  
容积约: 250ml



(原SFT814)

30.814.00.0060

小鱼模  
110x150x30mm  
容积约: 250ml



(原HSH03-B)

32.606.00.0060

9连复活节饼干模  
305x305x13mm  
容积约: 378ml

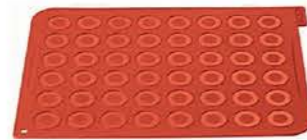

(原MAC01)

33.041.00.0060

马卡龙套装  
400x300x3mm



(原MAC02)

33.042.20.0060

70连马卡龙模  
380x575x2mm



(原MAC03)

33.043.00.0060

42连心型马卡龙  
400x300x2mm



(原SFT203)































30.203.00.0060

圣诞树模  
280x200x40mm  
容积约: 1050ml





工具系列	其他工具系列	蛋糕转台系列	打蛋器打蛋器系列	烙印模具系列	新娘花系列	蛋糕培系列	挤花袋系列	ONEWAY系列	花瓣系列	面杆系列	SILKOMART系列	WORLD系列	CHOCOLATE系列	巧克力模具系列
106	115	118	126	128	130	132	136	137	139	144	146	190	201	

- |  |   |  |   |  |
|--|---|--|---|--|
| <br>(原C3D01)<br><b>22.151.77.0065</b><br>树型巧克力模<br>303x303x11mm                       | <br>(原C3D02)<br><b>22.152.77.0065</b><br>蛋型巧克力模<br>305x305x15mm                        | <br>(原ACC086)<br><b>70.095.99.0065</b><br>巧克力填充器 圆径130x140mm                              | <br>(原ACC085)<br><b>24.003.77.0065</b><br>巧克力温度计 圆径185x65mm                            | <br><b>70.096.98.0062 (原ACC087)</b><br>巧克力温度计刮刀 320x70mm<br>温度使用范围: -0°C至+160°C       |
| <br>(原SCG17)<br><b>22.117.77.0065</b><br>12连点心巧克力模<br>215x105x15mm                    | <br>(原SCG01)<br><b>22.101.77.0065</b><br>15连心型巧克力模<br>210x105x25mm<br>中型30x22x25mm     | <br>(原SCG02)<br><b>22.102.77.0065</b><br>15连方型巧克力模<br>210x105x18mm<br>中型26x26x18mm        | <br>(原SCG03)<br><b>22.103.77.0065</b><br>15连球型巧克力模<br>210x105x20mm<br>中型圆径28x20mm      | <br>(原SCG04)<br><b>22.104.77.0065</b><br>15连布丁巧克力模<br>210x105x20mm<br>中型圆径28x20mm     |
| <br>(原SCG05)<br><b>22.105.77.0065</b><br>14连复活节巧克力模<br>215x107x16mm<br>中型30x43x16mm  | <br>(原SCG06)<br><b>22.106.77.0065</b><br>12连圣诞节巧克力模<br>215x107x20mm<br>中型34x34x18.5mm | <br>(原SCG07)<br><b>22.107.77.0065</b><br>15连瓶盖巧克力模<br>215x107x20mm<br>中型圆径30x18.5mm      | <br>(原SCG08)<br><b>22.108.77.0065</b><br>15连弯尾花巧克力模<br>215x107x20mm<br>中型30x30x15.5mm | <br>(原SCG09)<br><b>22.109.77.0065</b><br>14连JACK巧克力模<br>215x107x18mm<br>中型37x20x20mm |
| <br>(原SCG10)<br><b>22.110.77.0065</b><br>8连叶型巧克力模<br>215x107x16mm<br>中型51x23x14.5mm | <br>(原SCG11)<br><b>22.111.77.0065</b><br>12连砖块巧克力模<br>215x107x5mm<br>中型38x28x4.5mm   | <br>(原SCG12)<br><b>22.112.77.0065</b><br>12连姜饼人巧克力模<br>215x107x15mm<br>中型43x35x12mm     | <br>(原SCG13)<br><b>22.113.77.0065</b><br>15连玫瑰巧克力模<br>215x107x18mm<br>中型圆径28x18mm    | <br>(原SCG14)<br><b>22.114.77.0065</b><br>14连时尚巧克力模<br>215x107x15mm<br>中型41x30x12mm  |
| <br>(原SCG15)<br><b>22.115.77.0065</b><br>12连公仔巧克力模<br>215x107x17mm<br>中型33x34x17mm  | <br>(原SCG16)<br><b>22.116.77.0065</b><br>12连恐龙巧克力模<br>215x107x16mm<br>中型40x33x16mm   | <br>(原SCG18)<br><b>22.118.77.0065</b><br>12连机器人巧克力模<br>215x107x17mm<br>中型39.5x26.7x16mm | <br>(原SCG19)<br><b>22.119.77.0065</b><br>15连咕咕霍夫巧克力模<br>215x107x17mm<br>中型28.5x15mm  | <br>(原SCG20)<br><b>22.120.77.0065</b><br>15连圆锥型巧克力模<br>215x105x32mm<br>中型圆径26x28mm  |
| <br>(原SCG21)<br><b>22.121.77.0065</b><br>15连马卡龙巧克力模<br>215x105x8mm<br>中型圆径26x28mm   | <br>(原SCG22)<br><b>22.122.77.0065</b><br>12连早餐巧克力模<br>215x105x14mm<br>中型39x24.5x13mm | <br>(原SCG23)<br><b>22.123.77.0065</b><br>15连冬天巧克力模<br>215x105x16mm<br>中型33x27x15mm      | <br>(原SCG24)<br><b>22.124.77.0065</b><br>15连春天巧克力模<br>215x105x15mm<br>中型36x36x15mm   | <br>(原SCG25)<br><b>22.125.77.0065</b><br>8连饼干巧克力模<br>215x105x8mm<br>中型49x29x6.8mm   |

001

017

020

028

036

042

050

058

064

072

080

090

106

115

118

126

128

130

132

136

137

139

144

146

190

201



33.081.20.0196 (原TRD01)  
雏菊蕾丝糖模 400x80x1.8mm



33.082.20.0196 (原TRD02)  
蝴蝶蕾丝糖模 400x80x1.8mm



33.083.20.0196 (原TRD03)  
花型蕾丝糖模 400x80x1.8mm



33.089.20.0069 (原TRD09)  
叶子蕾丝糖模 400x80x1.8mm



33.090.20.0069 (原TRD10)  
阔叶蕾丝糖模 400x80x1.8mm



33.093.20.0069 (原TRD13)  
小鸟型蕾丝糖模 400x80x1.8mm



33.097.20.0069 (原TRD17)  
糖果派对蕾丝糖模 400x200x1.8mm



33.088.20.0069 (原TRD08)  
优雅蕾丝糖模 400x200x1.8mm



72.341.20.0096 (原SI3341)  
翻糖塑型轮刀组-5入 圆径22x95mm

蕾丝模使用图示



(原TAG01)  
25.961.20.0065 圆型切模-2入  
圆径10/30x10mm 圆径20/40x10mm



(原TAG02)  
25.962.20.0065 心型切模-2入  
圆径10/30x10mm 圆径20/40x10mm



(原TAG03)  
25.963.20.0065 梅花型切模-2入  
圆径10/30x10mm 圆径20/40x10mm



(原TAG04)  
25.964.20.0065 蛋糕型切模-2入  
圆径10/30x10mm 圆径20/40x10mm

工具系列	其他工具系列	蛋糕转台系列	打蛋盆打蛋器系列	烙印模系列	新娘花系列	蛋糕塔系列	挤花袋系列	ONEWAY系列	花瓣系列	面杆系列	SILKOMART系列	CHOCOLATE WORLD系列	巧克力模具系列
106	115	118	126	128	130	132	136	137	139	144	146	190	201

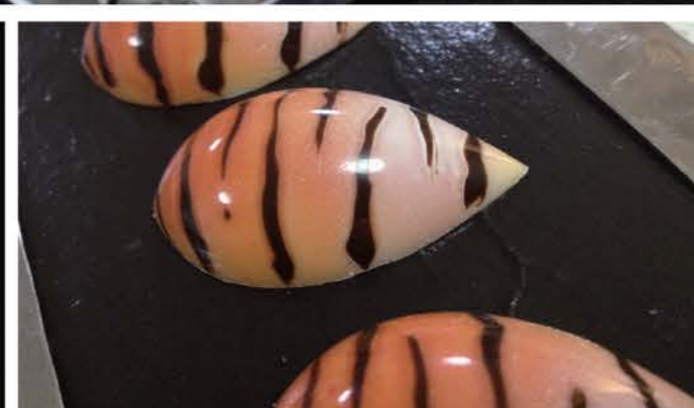

注：1格令 (gr)=0.0647989克  
编号

**CW1727** 模具外尺寸、每盘数量  
275x135x24mm (3x6pcs)  
37.5x32x12.5mm (2x7.5gr) 单枚规格、单枚克重



**CW1576**  
275x135x24mm (3x7pcs)  
29x34.4x17mm (12gr)



**CW1145**  
275x135x24mm (2x4pcs)  
65x57x14mm (35gr)



**CW1744**  
275x135x24mm (3x8pcs)  
35x22.5x16mm (10.5gr)



**CW1513**  
275x135x24mm (2x7pcs)  
34x33x8mm (2x8.6gr)



**CW1023**  
275x135x24mm (3x6pcs)  
30x22x12.5mm (2x6gr)



**CW1218**  
275x135x24mm (3x7pcs)  
30x36x19mm (14gr)



**CW2218**  
275x175x24mm (3x4pcs)  
52x46x11mm (25gr)



**CW2161**  
275x175x24mm (3x6pcs)  
104x88x18mm (100gr)



**CW2383**  
275x175x24mm (4x6pcs)  
33x23x11mm (2x7.5gr)



**CW2080**  
275x175x24mm (4x8pcs)  
30x26x9mm (2x5gr)



**CW1214**  
275x135x24mm (3x6pcs)  
31x35x18mm (15gr)



**CW2143**  
275x175x24mm (6x10pcs)  
圆径20x8mm (2gr)



**CW1417**  
275x135x24mm (3x8pcs)  
33x31x15mm (11gr)

001

017

020

028

036

042

050

058

064

072

080

090



CW1726

275x135x24mm (3x12pcs)  
32x15.5x8mm (2.5gr)



CW2351

275x175x24mm (4x8pcs)  
49x26x17mm (15gr)



CW1297

275x135x24mm (1x7pcs)  
102x36x19mm (41gr)



CW1024

275x135x24mm (3x7pcs)  
31x31x20mm (15gr)



CF0608

275x135x24mm 上下双模具  
top圆径25x5.75mm  
botton 圆径25x13.25mm  
3x8pcs/4.5gr



CW1632

275x135x24mm (3x8pcs)  
34x20x26mm (2x5gr)



CF0609

275x135x24mm 上下双模具  
top圆径35x6.5mm  
botton 圆径35x18mm  
3x8pcs/13gr

106

115

118

126

128

130

132

136

137

139

144

146

190

201



CW1495

275x135x24mm (4x10pcs)  
圆径20mm (2x2.5gr)



CW1158

275x135x24mm (4x9pcs)  
圆径25mm (2x4gr)



CW1217

275x135x24mm (3x8pcs)  
圆径30mm (2x9gr)



CW2022

275x175x24mm (5x8pcs)  
圆径30mm (9gr)



CW1243

275x135x24mm (3x8pcs)  
圆径30mm (9gr)



CW1428

275x135x24mm (4x8pcs)  
圆径26mm (2x6gr)



CW1443

275x135x24mm (3x8pcs)  
圆径30mm (2x8.5gr)



CW2361

275x175x24mm (5x8pcs)  
27x27x13mm (2x6gr)



CW1653

275x135x30mm (2x5pcs)  
40x43x20mm (40gr)

001

017

020

028

036

042

050

058

064

072

080

090

106

115

118

126

128

130

132

136

137

139

144

146

190

201



CW1157

275x135x30mm (3x7pcs)  
圆径30x25mm (18gr)

CW1292

275x135x35mm (3x7pcs)  
圆径35x30mm (25gr)

CW1673

275x135x24mm (2x8pcs)  
45.5x25x12.5mm (2x10gr)

CW1631

275x135x24mm (3x6pcs)  
33x32x13mm (8gr)

CW2037

275x175x24mm (2x9pcs)  
66x23x12mm (2x11gr)

CW2038

275x175x24mm (2x6pcs)  
90x24x12mm (15gr)

CW1279

275x135x24mm (2x8pcs)  
43x23x20mm (15gr)

CW1317

275x135x24mm (3x8pcs)  
40x30x14mm (12gr)

CW1740

275x135x24mm (3x8pcs)  
39x18x16.5mm (8gr)

CW1622

275x135x24mm (2x5pcs)  
117x15x6.5mm (2x9.5gr)

CW1777

275x135x24mm (1x8pcs)  
258x10.5x5.25mm (5.5gr)

CW1533

275x135x24mm (1x10pcs)  
11.5x24x13mm (9gr)

CW1156

275x135x24mm (6x5pcs)  
37x18x14mm (11gr)

CW2305

275x175x24mm (4x8pcs)  
33x22x12mm (7gr)

CW2025

275x175x24mm (5x6pcs)  
40x20x13mm (10gr)

CW1548

275x135x24mm (3x7pcs)  
26x25x20mm (9gr)Designed and developed in cooperation  
with choconsult: [www.choconsult.com](http://www.choconsult.com)

001

017

020

028

036

042

050

058

064

072

080

090



CW1780

275x135x24mm (3x7pcs)  
46x28x21mm (10gr)

CW1782

275x135x30mm (3x6pcs)  
44.5x32x22.5mm (11gr)

CW1588

275x135x24mm (3x3pcs)  
67x33x5mm (12gr)

CW1025

275x135x24mm (3x8pcs)  
36x22x20mm (15gr)

CW1617

275x135x24mm (5x5pcs)  
39x18x15.5mm (10gr)

CW1730

275x135x24mm (3x8pcs)  
33.5x18x9.5mm (2x4gr)

CW1045

275x135x24mm (3x8pcs)  
30x27x19mm (13gr)

CW1646

275x135x24mm (3x8pcs)  
34x24x12mm (10gr)

CW2247

275x175x24mm (4x8pcs)  
36x26x18mm (18gr)

CW1059

275x135x24mm (3x8pcs)  
27x27x18mm (14gr)

CW1652

275x135x24mm (3x8pcs)  
26x26x14mm (10gr)

CW1036

275x135x24mm (3x8pcs)  
29x29x20mm (17gr)

106

115

118

126

128

130

132

136

137

139

144

146

190

201



CW1748

275x135x24mm (1x3pcs)  
64.5x66.5x9.5mm (43gr)

CW1749

275x135x24mm (3x7pcs)  
27.5x27.5x16.5mm (12gr)

CW1493

275x135x24mm (4x8pcs)  
直径28x16mm (10gr)

CW1741

275x135x24mm (5x7pcs)  
16.5x16.5x10mm (3gr)

CW1742

275x135x24mm (3x7pcs)  
30.5x30.5x7.5mm (6.5gr)

CW1743

275x135x24mm (3x7pcs)  
30.5x30.5x7.5mm (6.5gr)

CW1593

275x135x24mm (3x6pcs)  
34x34x11mm (13gr)

CW1260

275x135x35mm (3x7pcs)  
31x31x29mm (13gr)

CW1566

275x135x24mm (1x4pcs)  
117x48x5mm (40gr)

CW1557

275x135x24mm (3x6pcs)  
25.5x25.5x18.5mm (11.75gr)

CW1607

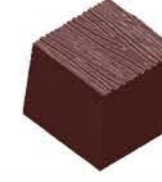
275x135x24mm (3x7pcs)  
27x27x14mm (10.3gr)

CW1676

275x135x24mm (4x8pcs)  
22.5x22.5x19.5mm (11.5gr)

001

017

020

028

036

042

050

058

064

072

080

090

**CW1003**275x135x24mm (3x8pcs)  
35x26x19mm (14gr)**CW1093**275x135x24mm (3x8pcs)  
37x29x14mm (2x7.5gr)

迷你咖啡豆造型

**CW2028**275x175x24mm (9x12pcs)  
19x13x7mm (1gr)**CW2339**275x175x24mm (4x8pcs)  
圆径29x16mm (12gr)**CW1564**275x135x24mm (3x7pcs)  
31x31x15.4mm (12.35gr)**CW1002**275x135x24mm (3x7pcs)  
圆径30x19mm (14gr)**CW1140**275x135x24mm (3x8pcs)  
圆径29x19mm (10gr)**CW1336**275x135x24mm (3x8pcs)  
圆径28x15mm (10gr)**CW1482**275x135x24mm (3x8pcs)  
圆径30x16mm (12gr)**CW1095**275x135x24mm (3x5pcs)  
49x36x13mm (17gr)**CW1058**275x135x24mm (3x7pcs)  
圆径28x20mm (12gr)**CW1113**275x135x24mm (3x8pcs)  
32x30x17mm (13gr)**CW1048**275x135x24mm (2x5pcs)  
圆径43x5mm (6gr)**CW1639**275x135x24mm (3x7pcs)  
50x50x14mm (2x2.5gr)

106

115

118

126

128

130

132

136

137

139

144

146

190

201

**CW1402**275x135x24mm (3x6pcs)  
50x20x11mm (2x6gr)**CW1084**275x135x24mm (2x8pcs)  
35x29x21mm (15gr)**CW1011**275x135x24mm (3x6pcs)  
42x32x19mm (16gr)**CW1210**275x135x24mm (4x8pcs)  
28x30x9mm (5gr)**CW1120**275x135x24mm (3x6pcs)  
38x35x9mm (2x7gr)**CW1070**275x135x24mm (3x8pcs)  
32x29x21mm (14gr)**CW1587**275x135x24mm (3x6pcs)  
52x22x7mm (2x7gr)**CW1674**275x135x24mm (2x4pcs)  
61x45x10mm (2x10gr)**CW1693**275x135x24mm (3x8pcs)  
32x23x9/31.5x22x9/37.5x22x9mm (5gr)**CW1073**275x135x24mm (3x8pcs)  
35x21x16mm (9gr)**CW1451**275x135x24mm (3x4pcs)  
74x30x8mm (14gr)**CW1028**275x135x24mm (3x8pcs)  
38x27x19mm (15gr)**CW1776**275x135x24mm(3x6pcs)  
顶圆径32x17.5/底圆径32x14.5mm (9+8.5gr)**CW1671**275x135x24mm (3x7pcs)  
30x30x15mm (9.5gr)

001

017

020

028

036

042

050

058

064

072

080

090



CW1727

275x135x24mm (3x6pcs)  
37.5x32x12.5mm (2x7.5gr)



CW1699

275x135x24mm (3x6pcs)  
35x33x12.5mm (2x6gr)



CW1739

275x135x24mm (1x4pcs)  
45.5x99.5x19mm (2x49gr)



CW1783

275x135x24mm (1x4pcs)  
125x41.5mm (27.5gr)



CW1779

275x135x24mm (3x5pcs)  
38.5x22.5x17.5mm (12.5gr)



CW1697

275x135x24mm (3x6pcs)  
33x25x11.5mm (2x5.5gr)  
33x25x15.5mm



CW1006

275x135x24mm (3x6pcs)  
38x27x16mm (15gr)



CW1771

275x135x24mm (2x7pcs)  
54.5x26x18mm (11.5+8gr)  
54.5x26x12mm



CW1781

275x135x24mm (2x7pcs)  
42.5x31x18.5mm (10.5gr)



CW1774

275x135x24mm (3x4pcs)  
47.5x27x15mm (2x9gr)



CW1698

275x135x24mm (3x6pcs)  
33x29x12.5mm (2x6gr)



编码: CW1856  
模具外尺寸: 275x135x24mm  
单品规格: 圆径48x37mm  
每盘: 2x6pcs



CW1691

275x135x24mm (2x6pcs)  
40x51x32.5mm (30gr)



CW1770

圆径90x5.5 (20gr) / 圆径81x5.5mm (16gr)  
圆径70x5.5 (12gr) / 圆径54x5.5mm (7.5gr)  
圆径39x5.5 (4gr) / 375x135x24mm (1x5pcs)



CW1745

275x135x24mm (3x5pcs)  
63x18x8mm (10gr)

106

115

118

126

128

130

132

136

137

139

144

146

190

201

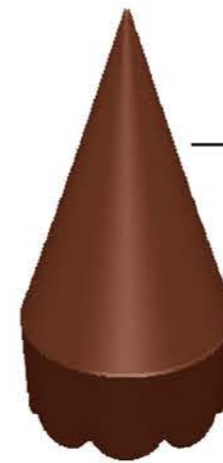

HM005

圆径68x120mm (2pcs)



CW1728

275x135x40mm



## 大规格巧克力模



HM004

170mm (1pcs)



HM012

170x161x75mm (1pcs)



巧克力月饼模

CW1542

54x54x16mm (39gr)  
275x135x24mm (2x4pcs)



HM008

150x113x113mm (1pcs)



HM009

124x165x115mm (1pcs)



HM006

194x200x164mm (40gr)(1pcs)

001

017

020

028

036

042

050

058

064

072

080

090



A款(带骰子)

B款

14pcs 单枚28.6x37.5mm

SN3077 巧克力模-麻将A款 275x135x24mm

SN3078 巧克力模-麻将B款 275x135x24mm



SN3060

巧克力模-半圆球  
242x72mm 14pcs  
直径30x15mm



SN3069

巧克力模-心型  
280x98mm 10pcs  
46x36x5mm



SN3062 巧克力模-向日葵 280x100mm



SN3070 巧克力模-圣诞 12pcs 280x98mm



12pcs 37x4mm

SN3061 巧克力模-十二生肖 280x100mm



SN3071 巧克力模-生日快乐中英文 280x100mm



106

115

118

126

128

130

132

136

137

139

144

146

190

201

### 果冻模 PP塑料



SN30904



SN30914



SN30904 水晶果冻模-2入 230x120x37mm

SN30914 水晶果冻模-2入 230x120x37mm



SN30744 巧克力模-2入(小熊) 175x175x17.5mm



SN30804 巧克力模-2入(小鸭) 175x175x16mm



SN30814 巧克力模-2入(心型/永恋一世) 175x175x16mm



SN30824 巧克力模-2入(猫爪) 175x175x16mm